

We thank you for having chosen one of our products, the fruit of technological experience and of continual research for a superior quality product in terms of safety, dependability, and service. In this manual you will find all the information and useful suggestions to use your product with the maximum safety and efficiency.



We highly recommend to turn to our Authorized Service Centre for the installation and the first ignition of the device as it not only carries out the installation perfectly but also verifies the regular operation of it.

- Incorrect installation, incorrectly performed maintenance, improper use of the product release the manufacturer from every eventual damage derived from the use of the thermostove.
- The unit cannot be used as an incinerator. Do not use fuels other than pellets.
- This manual has been realized by the manufacturer and constitutes an integral part of the product and must remain with it during its entire lifetime. If the product is sold or transferred, be sure that the booklet is present since the information contained in it are addressed to the buyer, and to all those persons of various titles who complete the installation, use and maintenance.
- Carefully read the instructions and the technical information contained in this manual, before proceeding with the installation, use, and any operation on the product.
- The observance of the indications contained in the present manual guarantees the safety of people and the product, the economy of use and a longer functioning lifetime.
- Although the carefully studied design and the risk analysis done by our company has permitted the realization of a safe product, in any case, before effecting any operation on the thermostove, it is recommended to keep said manual available and pay scrupulous attention to the instructions written therein.
- Be very careful when moving the ceramic details where present.
- Check the precise flatness of the pavement where the product will be installed
- The wall where the product will be placed must not be constructed in wood, or in any case, made of an inflammable material, and in addition it is necessary to maintain a safety distance.
- While the thermostove is in operation, several parts of the thermostove (door, handle, sides) can reach high temperatures. Therefore pay attention and use the proper precautions, above all in the presence of children, elderly or disabled persons, and animals.
- Assembly must be performed by authorized persons (Authorized Assistance Center).
- Diagrams and drawings are furnished for the purpose of illustration; the manufacturer, with the intent of pursuing a policy of constant development and renewal of the product can, without any notice, make any modifications that are believed opportune.
- When the thermostove is working at its maximum speed, it is strongly suggested to wear gloves while handling with the door for pellets loading and the door handle.
- It is prohibited to install in bedrooms or in explosive environments.
- Only use replacement parts recommended by the supplier.



Never cover the body of the thermostove in any way or obstruct the openings placed on the upper side when the device is operating. All our stoves are trial lighted on the construction line.

In the event of a fire, disconnect the power supply, use an extinguisher and call the fire fighters if necessary. After that contact the Authorized Assistance Center.

This instruction booklet is an integral part of the product: make sure that it always accompanies the appliance, even in case of transfer to another owner or in the case of transfer to another place. In the event of damage or loss, request a copy from the area technician.

These symbols indicate specific messages in this booklet:

**ATTENTION:**

This warning sign indicates that the message to which it refers should be carefully read and understood, **because failure to comply with what these notices say can cause serious damage to the thermostove and put the user's safety at risk.**

**INFORMATION:**

This symbol is used to highlight information which is important for proper thermostove operation. Failure to comply with these provision will compromise use of the thermostove and its operation will not be satisfactory.

Norms and declarations of conformity

Our company declares that the thermostove conforms to the following norms for the EC European Directive labelling:

- 2014/30 UE (regulation EMCD) and following amendments;
- 2014/35 UE (Low Voltage Directive) and following amendments;
- 2011/65 EU (RoHS 2 directive);
- The Rules of Construction Products (CPR-Construction Products Regulation) No. 305/2011 regarding the construction world;
- For installations in Italy, please refer to UNI 10683/98 or following changes. **While installing the unit respect the local, national and European rules;**
- EN 55014-1; EN 55014-2; EN 61000-3-2; EN 61000-3-3; EN 60335-1; EN 60335-2-102; EN 62233, EN 50581.

Safety information

Please carefully read this use and maintenance manual before installing and operating the thermostove!

If clarification is needed, please contact the dealer or the Authorized Assistance Center.

- The pellet thermostove must only be operated in living environments. This thermostove, being controlled by an electronic board, permits a completely automatic and controlled combustion; the exchange, in fact, regulates the lighting phase, 5 power levels and the shut down stage, guaranteeing the safe operation of the thermostove.
- The basket used for combustion allows most of the ash produced by the combustion of the pellets to fall into the collection compartment. Nevertheless, check the basket daily, given that

not all pellets have high quality standards (use only quality pellets recommended by the manufacturer).

Responsibility

With the delivery of the present manual, we decline all responsibility, both civil and penal, for accidents deriving from the partial or total lack of observance of the instructions contained herein.

We decline every responsibility derived from improper use of the thermostove, from incorrect use by the user, from unauthorized modifications and/or repairs, from the use of replacement parts that are not original for this model. The manufacturer declines every civil or penal, direct or indirect responsibility due to:

- Lack of maintenance;
- Failure to observe the instructions contained in the manual;
- Use in non-conformity with the safety directives;
- Installation in non-conformity with the norms in force in the country;
- Installation by unqualified or untrained personnel;
- Modifications and repairs not authorized by the manufacturer;
- Use of non-original replacement parts;
- Exceptional events.

Charge pellet

Fuel is loaded from the upper part of the thermostove by opening a door.

Pour the pellets in the hopper. This is easier if performed in two steps:

- Pour half of the contents of the bag into the hopper and wait for the fuel to settle on the bottom.
- Then pour in the second half;
- Keep the cover closed , after loading the pellets , the lid of the fuel tank;
- Before closing the door load-pellet make sure that there are no residues of pellets around the seal. If carefully cleaned to avoid compromising the seals.

The thermostove is a product by heating, presents the external surfaces particularly hot.

For this reason, we recommend extreme caution when operating in particular:

- Do not touch the thermostove body and the various components, do not approach the door , it could cause burns;
- Do not touch the exhaust fumes;
- Do not perform any type of cleaning;

- Do not dump the ashes;
- Do not open the ash tray;
- Be careful that children do not come near;



Never remove the protection grille in the hopper. When filling, do not let the sack of pellets touch any hot surfaces.



- **Use only wood pellets;**
- **Keep / store the pellets in a cool dry place;**
- **Never pour pellets directly on the hearth;**
- **The thermostove must only be fed with quality 6 mm diameter pellets, A1 certified according to the UNI EN ISO 17225-2 regulations;**
- **Before making the electrical connection of the thermostove the discharge tubes must be connected with the flue;**
- **The protective grill placed inside the pellet container must never be removed;**
- **The environment where the thermostove is installed must have a sufficient exchange of air;**
- **It is forbidden to operate the thermostove with the door open or the glass broken;**
- **Do not use the thermostove as an incinerator; the thermostove should be used only for the intended purpose;**
- **Any other use is considered improper and therefore dangerous. Do not put in the hopper other than wood pellets;**
- **When the thermostove is operating, the surfaces, glass, handle and tubes become very hot: during operation do not touch these parts without adequate protection;**
- **Keep the fuel and other inflammable materials off the thermostove.**

Instructions for safe and efficient use

- The device can be used by children that are not less than 8 years old and people with reduced physical, sensory or mental capabilities, or lack of experience or knowledge, provided being under supervision of someone responsible or after having received instructions relating to the safe use of the device and to the understanding of the dangers inherent to it. Children should not play with the device. Cleaning and maintenance to be performed by the user should not be made by children without supervision;
 - Do not use the thermostove as a ladder or scaffold;
 - Do not put clothes to dry on the thermostove; Any clothes hangers and suchlike must be kept a suitable distance from the thermostove. - Risk of fire;
 - Carefully explain that the thermostove is made from material subjected to high temperatures for the elderly, the disabled, and in particular for all children, keeping them away from the thermostove during operation;
 - Do not touch the thermostove with wet hands: the thermostove has electrical components that could produce sparks if handled incorrectly;
 - Never open the glass door of the pellet thermostove while the thermostove is in operation;
 - The thermostove must be connected to an electrical system equipped with an earthing conductor in accordance with regulations 73/23 and 93/98 EEC;
 - The system must be of adequate electrical power declared the thermostove;
 - Do not wash the inside of the thermostove with water.
The water could damage the electrical insulation, causing electric shock;
 - Do not expose your body to hot air for a long time. Do not overheat the room you are in and where the thermostove is installed. This can damage the physical conditions and cause health problems;
 - Do not expose to direct the flow of hot air plants or animals;
 - The pellet thermostove is not a cooking element;
 - External surfaces during operation can become very hot. Do not touch them except with the appropriate protection;
 - The plug of the device power cable must be connected only after installation and assembly of the device and must remain accessible after installation, if the unit is not provided of a double-pole switch suitable and accessible.
- Pay attention that the power cord (and any other cables external to the appliance) do not touch hot parts.
 - Do not lay objects, glasses, infusers, room perfumers on the thermostove, they could be damaged or to damage the thermostove (in this case de warranty does not respond).
 - In the event of a start-up system, do not force switch on;
 - Unburnt pellet accumulation in the burner following "no switch on" must be removed before proceeding with new switch on. Before each restart, ensure the grate is well positioned and clean;
 - It is forbidden to manually load the fuel in the grate. Non-compliance with this warning can generate dangerous situations;
 - Evaluate the static conditions of the surface on which the weight of the product gravitates;
 - Extraordinary maintenance operations must be carried out by authorised and qualified staff only;
 - Disconnect the electrical power supply of the product before carrying out any maintenance operation;
 - On first start-up, smoke may generate due to initial heating of the paint. Keep the premises well ventilated.

Operating area

For proper functioning and a good temperature distribution, the thermostove should be positioned in a location where it is able to take in the air necessary for combustion of the pellet (about 40 m³/h must be available), as laid down in the standard governing the installation and in accordance with local national standards. The volume of the room must not be less than 20 m³. It is compulsory to install an adequate outdoor air intake which would allow oxidising air input necessary for correct operation of the product. The air flow between the outside and the installation premises can take place directly, through an opening on an external wall of the premises (preferred solution, see Figure 1a); or indirectly, through air intake from the adjoining premises with air intake and permanently communicating with the installation premises (see Figure 1b). Adjoining premises excludes those used as bedrooms, bathrooms, garages, common areas of a building and, in general, premises in danger of catching fire. Consider the doors and windows present which could interfere with correct air flow to the thermostove and maintain 1.5 metres from any smoke outlet. The air intake must have a minimum total net surface of 100 cm² protected by an external grate which must not be obstructed and/or blocked and which should be periodically cleaned: the aforementioned surface should be increased as a result if there are other active generators inside the premises (for example: electric fans for stale air extraction, kitchen hood, other stoves, etc...), which could generate a negative pressure environment. A check is necessary, with all the equipment on, that the drop in pressure between the room and the outdoors does not exceed a value of 4 Pa.

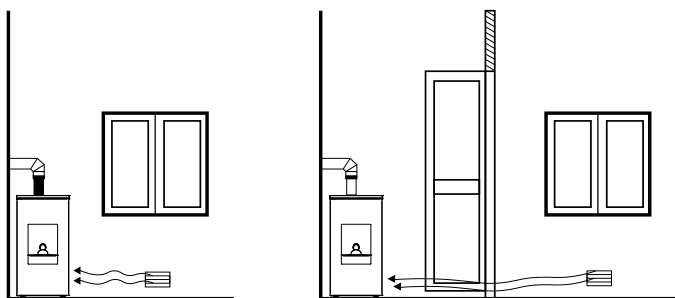

FIGURE 1a- DIRECTLY FROM OUTSIDE

FIGURE 1b- INDIRECTLY FROM ADJACENT PREMISES

You can connect the air necessary for combustion directly to the external air intake, with a tube of at least 50mm, with a maximum length of 2 linear metres; each curve of the tube is equal to a loss of one linear metre.



Installation in studio flats, bedrooms and bathrooms is only permitted for airtight or closed chamber equipment with an adequate canalization for oxidising air duct outwards. The thermo-stove with self-cleaning brazier sucks air both from the rear air intake pipe and from the slots on the front side. For this reason, the installation of the thermo-stove with self-cleaning brazier in bedrooms or bathrooms is always prohibited.

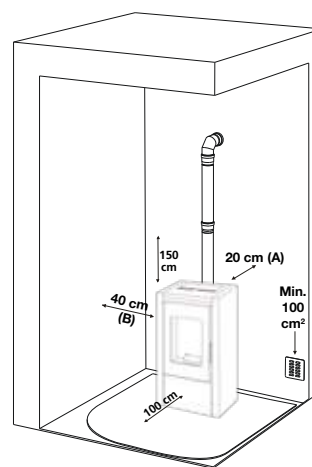

It is not permissible to install the thermostove in bedrooms, bathrooms, or in a room where another heating appliance is installed (fireplace, thermostove etc.) which does not have its own independent air intake. Locating the thermostove in a room with an explosive atmosphere is prohibited. The floor of the room where the thermostove is to be installed must be strong enough to take its weight. If walls are flammable, maintain a minimum distance of 20 cm at the rear (A), of 40 cm at the side (B) and 100 cm at the front. If the room contains objects which are believed to be particularly delicate, such as drapes, sofas and other furniture, their distance from the thermostove should be considerably increased.



In the presence of wood floors, install a floor protection surface in compliance with the rules in force in the country

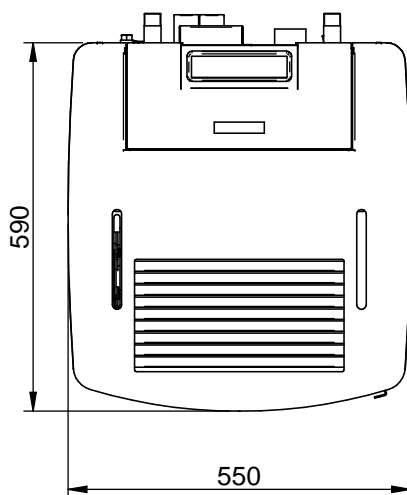
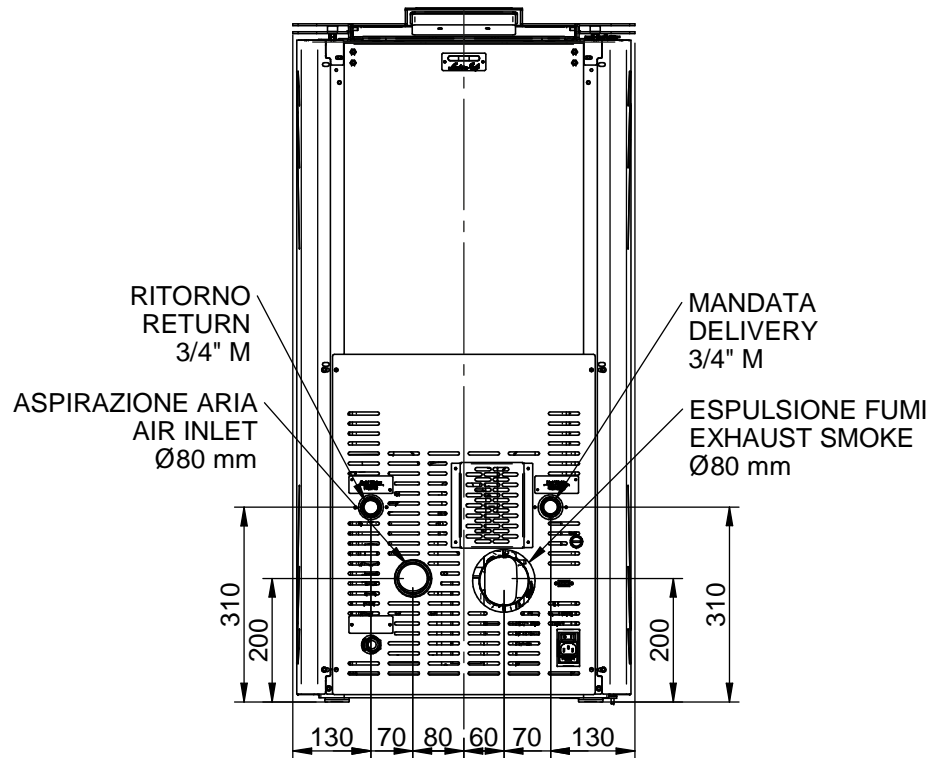
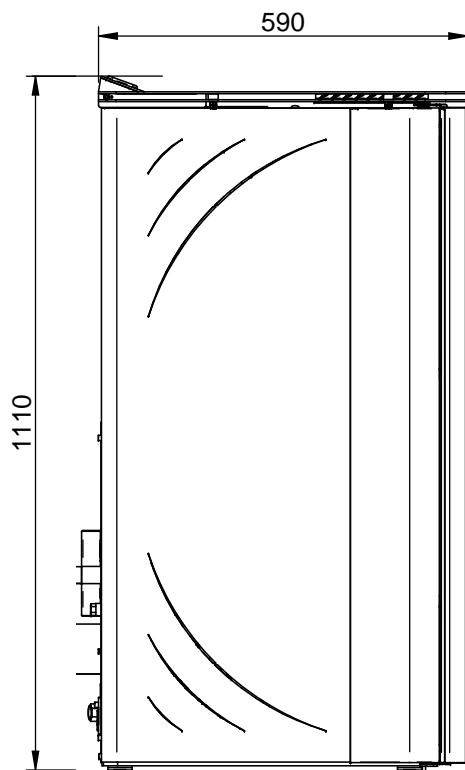

REMARKS:

- measurements are approximate and may vary based on to the aesthetics of the thermosave
- the positions of the tubes in the rear view are indicative and tolerance of +/- 10 mm
- measures with a tolerance of about 10 mm

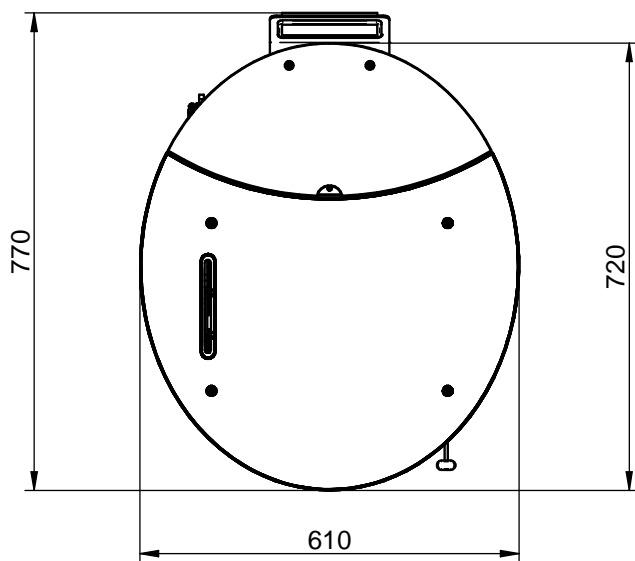
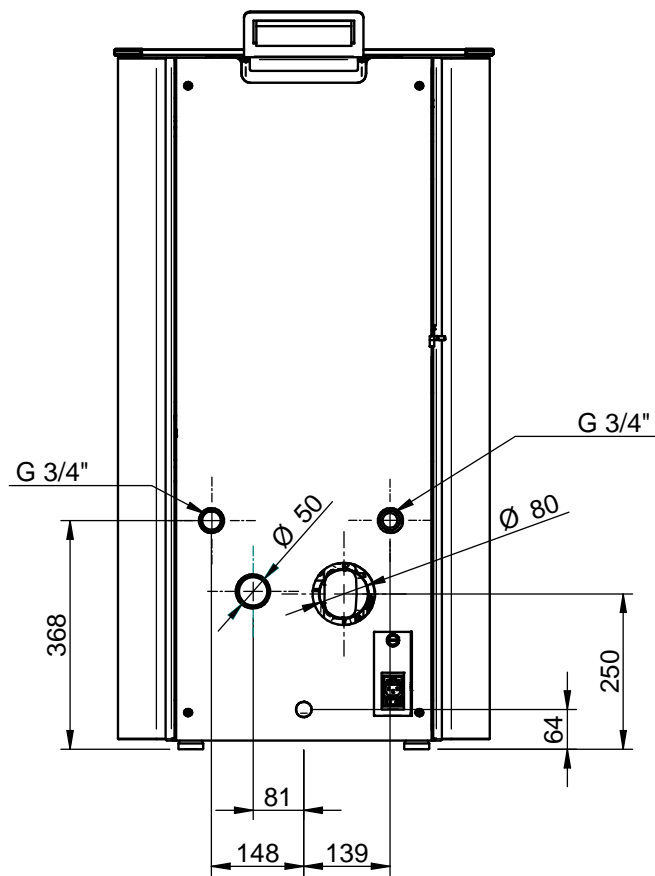
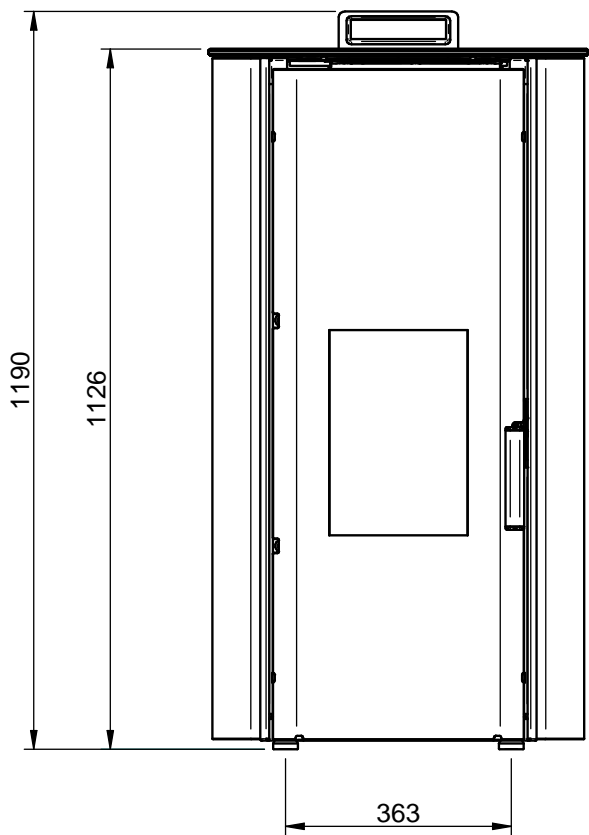

REMARKS:

- measurements are approximate and may vary based on to the aesthetics of the thermoset oven
- the positions of the tubes in the rear view are indicative and tolerance of +/- 10 mm
- measures with a tolerance of about 10 mm

PARAMETER	UNIT OF MEASURE	TH17	IDRO17-DD-AU XSAT170-DD-AU REDONDAGLTH17-AU
Heat input	kW	18,03	17,6
Nominal heat output	kW	17,14	16,5
Reduced nominal heat output	kW	4,00	5,4
CO concentration at nominal reference (13% O2)	kW	13,70	15,0
CO concentration at reduced reference (13% O2)	kW	3,10	4,4
Nominal efficiency	mg/m ³	48,23	42
Reduced efficiency	mg/m ³	345,4	95
Flue gas rate (min-max)	%	94,90	94,2
Draft advised (min-max)	%	97,54	95,0
Flue gas temperature (min-max)	Kg/h	0,84 - 3,79	1,19 - 3,66
Tank capacity	mc	430	430
Recommended fuel	g/s	3,02 - 11,04	5,5 - 10,3
Heated surface	Pa	3 - 8	5 - 10
Diameter flue outlet tube	°C	51,1 - 103	69 - 108
Diameter air intake	litri	31	31
Nominal voltage	Bar	3	3
Nominal frequency	Kg	33	33
Ignition power consumption	mm	80	80
Power consumption (min-max)	mm	50	50
Thermostove weight	Inch	3/4	3/4
IEE	V	230	230
Environmental decree n. 186 of 7/11/2017	Hz	50	50
N° Test Report	W	370	340
Powders at (13% O2) Ref. nominal heat input	Kg	160	160
Energy efficiency index		130	133
N° Test Report		K 1969 2016 T1	K 2841 2020 T1
Environmental decree n. 186 of 7/11/2017		★★★★☆	★★★★★
Energy class		A++	A++
Powders at (13% O2) Ref. nominal heat input	mg/m ³	15	12

It is recommended to control emissions after installation.

With obvious floor capacity evaluation, in the installation premises, a maximum can be deposited of fuel, which corresponds to approx. 975kg of pellets.

In order to achieve the test report results, please load the performance parameters retained by the manufacturer and the qualified technician. They will use these parameters once verified that, during the installation, it is possible to reproduce the laboratory conditions.

Flue

The following instructions have the purpose of giving instructions on installation of a good flue, however they do not replace in any way the standards in force of which a qualified builder must be aware. The thermostove manufacturer cannot be held in any way liable in civil or criminal terms for poor operation of the thermostove due to a wrongly sized flue and/or non-compliance with legislation in force, which must be complied with. The flue must be built to standard and category \geq T200 or higher, with a vertical progression without choking, resistant to condensate and resistant to fire caused by soot. It must be externally insulated to avoid smoke cooling and it must have a condensate drain. If the flue is a cement shaft, it must be ducted. The flue must be inspected for cleaning and must also be distanced from flammable and/or combustible materials. The opening area for smoke evacuation must be at least double the section of the flue and must prevent snow and animals from entering. The measurement of the opening in the atmosphere must be outside the backflow zone caused by the shape of the roof and/or any obstacles found nearby. Pay attention to the presence of skylights and dormer windows.

The minimum distances to comply with from any chimneys or reflux zones are outlined below.

Check the negative pressure between the flue and the environment installed comply with the instructions in the technical characteristics. The minimum height of the flue is 3.5 metres and must have an internal section that allows compliance with these requirements and however not over 100mm. Check the correct configurations using UNI EN 13384-1.

The flue must always be clean. Any soot residue reduces the section of the flue which would compromise draught and the soot could catch fire. Have a professional chimney sweep clean the flue and the chimney at least once a year and before switching on the generator after periods of inactivity. Lack of cleaning will negatively impact correct operation of the equipment.



Installation of the flue is not permitted shared with other equipment.

Chimney

The opening area for smoke evacuation must be at least double the section of the flue and must prevent snow and animals entering. The measurement of the opening in the atmosphere must be outside the backflow zone caused by the shape of the roof and/or any obstacles found nearby. Pay attention to the presence of skylights and dormer windows.

FLAT ROOF

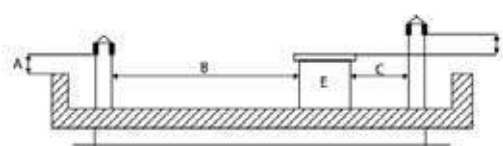

- A = MIN. 0,50 m
- B = DISTANCE > 2,00 m
- C = DISTANCE < 2,00 m
- D = 0,50 m
- E = TECHNICAL VOLUME

IMM 2

15° ROOF

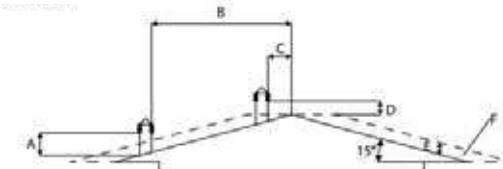

- A = MIN. 1,30 m
- B = DISTANCE > 1,50 m
- C = DISTANCE < 1,50 m
- D = 0,50 m OVER THE RIDGE
- E = 0,80 m
- F = BACKFLOW ZONE

IMM 3

30° ROOF

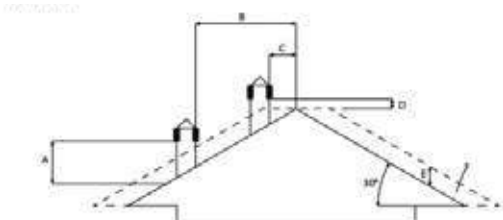

- A = MIN. 1,30 m
- B = DISTANCE > 1,50 m
- C = DISTANCE < 1,50 m
- D = 0,50 m OVER THE RIDGE
- E = 0,80 m
- F = BACKFLOW ZONE

IMM 4

60° ROOF

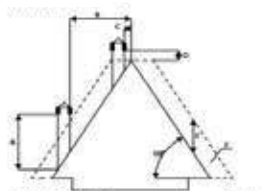

- A = MIN. 2,60 m
- B = DISTANCE > 1,20 m
- C = DISTANCE < 1,20 m
- D = 0,50 m OVER THE RIDGE
- E = 2,10 m
- F = BACKFLOW ZONE

IMM 5

45° ROOF

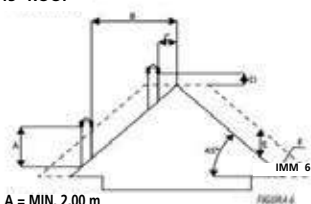

- A = MIN. 2,00 m
- B = DISTANCE > 1,30 m
- C = DISTANCE < 1,30 m
- D = 0,50 m OVER THE RIDGE
- E = 1,50 m
- F = BACKFLOW ZONE

IMM 6

Flue connection

The joint between the Thermostove and the flue must be installed using suitable tubes (min. T200). Use is forbidden of flexible metal tubes, in cement fibre or aluminium. The slope of the smoke duct must not have horizontal sections over 2 metres and must have a minimum 3% inclination. The first change of direction must take place after at least 1.5 metres of the vertical section. Inspect the base of the smoke duct

with periodic controls. It is forbidden to connect the same smoke duct on multiple equipment. Keep the smoke duct an adequate distance from any flammable parts or parts sensitive to heat. Refer to the instructions given by the manufacturer of the flue for the distances to respect.

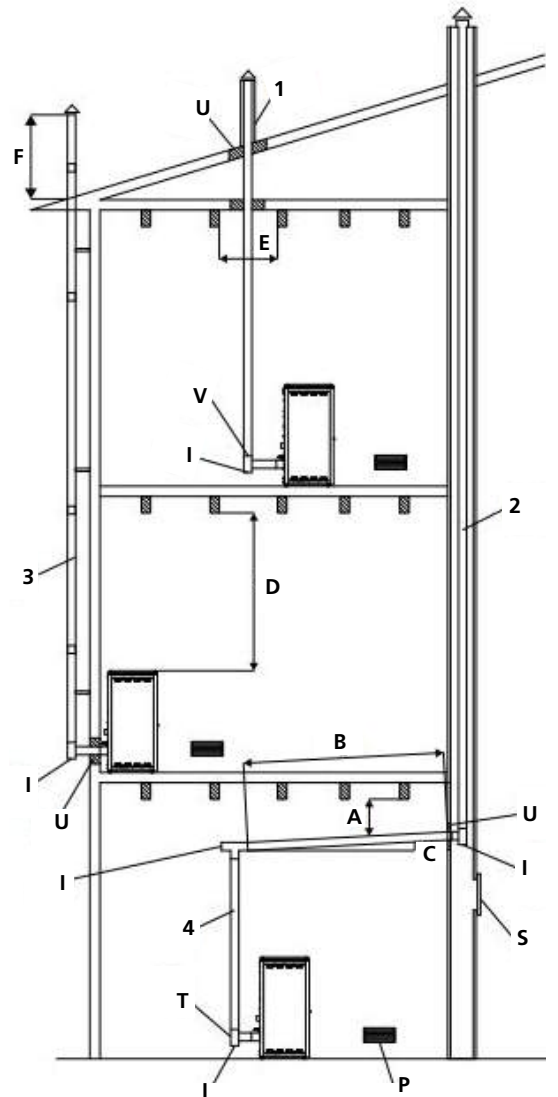

A= MINIMUM 40 MM
B= MASSIMUM 4 M
C= MINIMUM 3°
D= MINIMUM 400 MM
E= DIAMETER OF HOLE
F= SEE FIG. 2-3-4-5-6

U= INSULATION
V= POSSIBLE REDUCTION FROM 100 TO 80 MM
I= INSPECTION PLUG
S= INSPECTION DOOR
P= AIR INTAKE
T= T JOINT WITH INSPECTION PLUG

Remote Control

The remote control (Fig. 3) used to adjust water temperature power and the on/off functions for the pellet Thermostove.

To start the Thermostove, press key \odot and the Thermostove will automatically enter the starting phase.

Press keys \uparrow + (1) and \downarrow - (2) to adjust temperature, and use keys \uparrow + (6) and \downarrow - (5) to adjust operating power.

To turn off the Thermostove, hold down key \odot .

To replace the 3 volt battery located on the back of the remote control, pull the centre of the cover and the lever on the side of the same, replace the battery observing the correct polarity (Fig. 4)



Fig. 3



Fig. 4

Directions for use

If the installation of the thermostove provides interaction with another existing system complete with a heater (gas thermostove, gas thermostove, oil thermostove, etc..) consult qualified personnel who can then answer the compliance of the system, as envisaged by the law in force.

Flushing the system

In accordance with the UNI-CTI 8065 is strongly recommended to wash the entire system before connecting it in order to get rid of residues and deposits.

After flushing the system to protect it against corrosion and deposits, it is recommended the use of inhibitors. Upstream from the thermostove, always install shutters so as to disconnect it from the plumbing system should it be necessary to move it, or when it requires routine and/or special maintenance. Connect the thermostove using hoses so that the thermostove is not too strictly connected to the system, and to allow slight movement.

These are as helpful as the supply and return piping system if the heating system is on a higher floor than the thermostove.

The exhaust pipe pressure is connected temporarily to a carafe or a funnel to avoid, in case of overpressure, that the water gush bathrooms and the structure and the floor.



Replenishment of the System

The replenishment has to be slowly carried out in order to let the air bubbles flow out through the right outlets that are placed on the heating system. In heating systems with a closed circuit the loading cold pressure of the system and the inflation pressure of the expanding vase must correspond.

- in heating systems with open vase, the direct contact between the circulating liquid and the air is allowed. During the heating-season the user must regularly check the circulating water level in the expansion vase. The content of water in the system of recirculation must be stable hold.

Experiences show that the user must regularly check the water level every 14 days in order to maintain a stable water content.

The replenishment process must be carried out in case of necessity of more water when the thermostove has cooled down.

These preventive measures aim to prevent the insurgence of thermic stress of the steel body of the thermostove.

- in systems with open vase, the pressure of water in thermostove, when the system is cold, mustn't be lower than 0,3 bar;

- the water used to fill up the heating system must be decontaminate and without air.



You must not mix water of the heating system with antifreeze or anticorrosion substances in wrong concentrations. This could ruin the seals and provoke the insurgence of noises while operating. The producer refuses any responsibility for damages towards persons, animals or things if this warning will not be respected.

When all the hydraulic connections are done, proceed to test the pressure of the seals, through the filling of the heating thermostove.

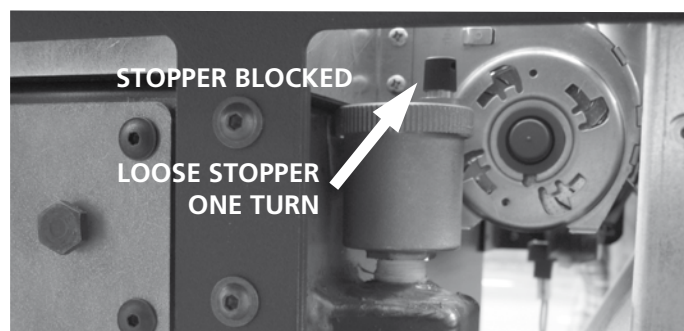

The loading valve is required and must be provided in the hydraulic system.

This operation must be carried out with caution following these steps:

- open the vent's valve of the radiator ,of the thermostove and the system;
- Gradually open the filling tap of the system checking that the automatic vent's valves, placed on the system, are regularly working;
- Close the vent's valves of the radiators as soon as the air flows out;
- check through the pressure gauge placed in the system that the pressure is reaching 1 bar (this is required only for systems with closed vase, you have to look for local rules that allow it); whereas for systems with open vase the restoration will be automatic;
- Close the filling tap of the system and then let the air flow out again through the vent's valve of the radiator;

Water Characteristics

The characteristics of the water used to fill the system are very important to prevent the build-up of mineral salts and the formation of incrustations along the pipes, in the thermostove and in the heat exchangers. Therefore, please get your plumber's advice concerning:

- Hardness of water circulating in the system, to prevent problems of incrustation and limescale, especially in the domestic water heat exchanger (>15° French).
- Installation of a water softener (if water hardness > 15° French).
- Filling the system with treated water (demineralised).

If you have very extensive system, with a large amount of water, or which require frequent refilling, it is recommended the installation of water softening system. It 'should be noted that the encrustations drastically reduce performance because of their low thermal conductivity.

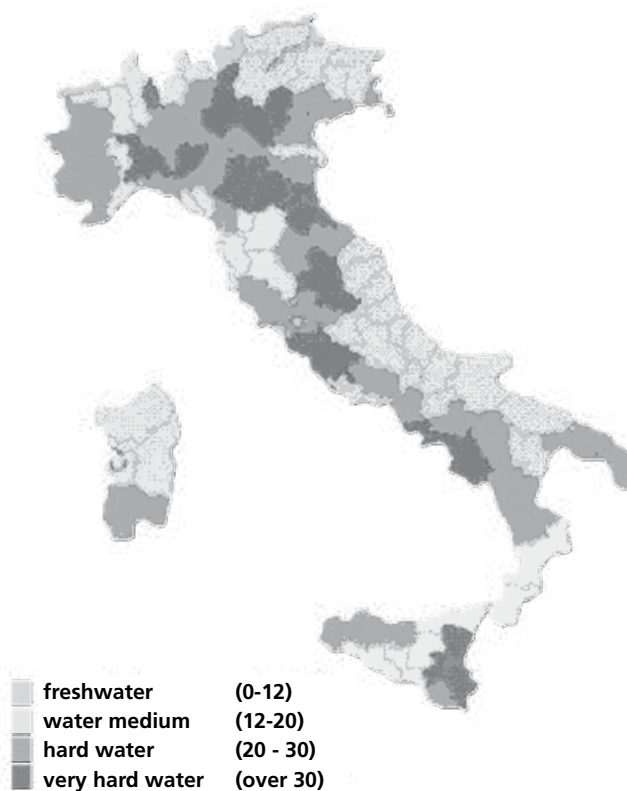

Pellet

The pellets are cylinders of compressed wood, produced from sawdust and wood processing (chips and sawdust), generally produced by sawmills and carpenters. The binding capacity of the lignin contained in wood, allows to obtain a compact product without adding additives and foreign chemicals to the wood, is therefore obtained a natural fuel with high yield.

The use of expired pellets or any other unsuitable material can damage parts of the thermostove and impair proper operation: this can lead to the termination of the guarantee, and its producer responsibility.



For our products use pellets diameter 6 mm, length 30 mm and a maximum of 8% and A1 certified according to the UNI EN ISO 17225-2 standard. Keep the pellets away from heat sources and not in humid environments or with explosive atmosphere.

Configuration of the hydraulic diagram of the thermostove

BY A SPECIALIZED TECHNICIAN

Before starting the thermostove, it is necessary to configure the hydraulic scheme on which we want to work. The thermostove is set up to receive the clean contact of an external thermostat (open / closed, the thermostat must not give tension to the back. If the thermostat carries voltage to the board causing faults, the warranty is void), two temperature probes and a motorized valve . All these components can be connected via the terminal board on the back of the thermostove.

Electrical diagram of the control unit



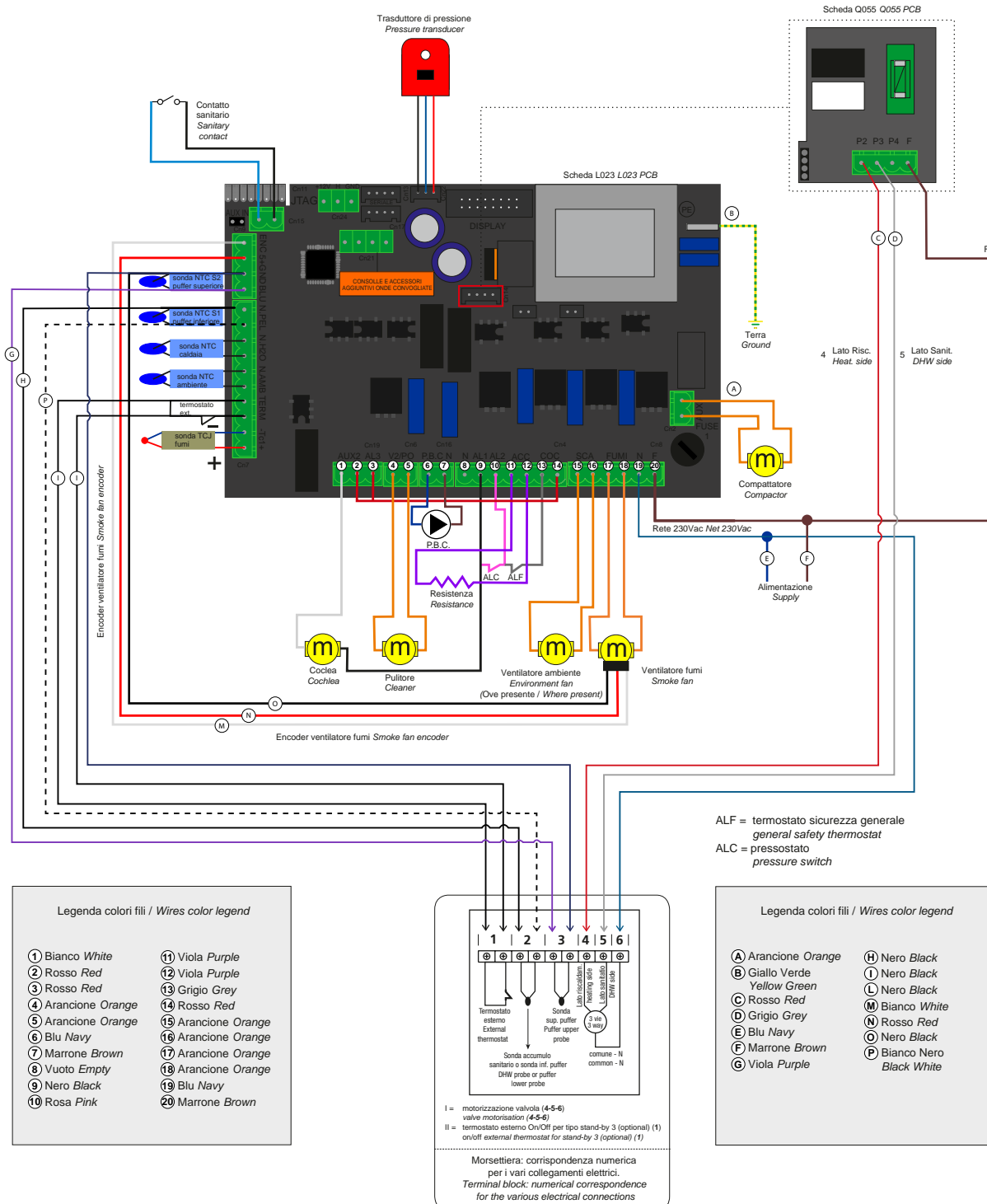

Schema connessioni elettriche termostufa / Thermostove electrical connection diagram



Collegamento a cura dell'eletttricista installatore, da realizzare seguendo lo schema sopra riportato / Connection by the installer electrician, to be carried out following the diagram above

Diagram for illustrative purposes, the terminal block is not supplied with the thermostove.

By a specialized technician

To configure the hydraulic diagram, press the SET key and then  scroll to the “Technical settings” menu with the power key. Press the SET key again to enter the menu and enter the access key in possession of only the technician authorized by the manufacturer. Confirm the password using the set key and the key  of the power go to menu 3 “hydraulic scheme”. Confirm with the SET key and use the  and  keys to select the required hydraulic scheme number.

For end user:

It is possible to change the thermostove operating principle according to the season by choosing between summer and winter. To select the season press SET, the season selection will appear on the display. Then press the set key again and select the season with keys 1 and 2. Once selected, press the ON / OFF key to exit. The choice of season changes the thermostove operation, see next chapter.

Following the principles of operation of the various hydraulic diagrams.

Important considerations:

- healthcare will always have priority
- There are three types of stand-by:
 - Type 01: the ambient temperature detected by the probe on the board has reached the SET AIR set
 - Type 02: the water temperature in the thermostove has reached the SET H2O set
 - Type 03: the external thermostat has detected that the desired temperature has been reached and therefore the contact is open.



In this specific case the thermostove behaves as follows:

If the thermostat carries voltage to the card causing faults, the warranty will expire.

To configure the thermostat, simply remove the jumper on the THERM terminal (see the tab on page 16) and connect our room thermostat, OPERATION BY A SPECIALIZED TECHNICIAN.

How to select the type of Stand-by (OPERATION BY A SPECIALIZED TECHNICIAN):



Press the SET button; press button  to go to menu 09. Press the SET button again. Enter the access key and confirm it by pressing the SET key again. Press the  key to go to menu 9-5.

The display will show the different stand-by modes mentioned above, choose the mode using the  and  keys.

NOTE: The hydraulic scheme 00 is set by default, the WINTER season with stand-by mode 02.

When the thermostove is switched off manually or by programming, automatic ignitions exit from a stand-by state will not be possible.

How to enable or disable the stand-by mode:

Press the SET button. With the , key, go to menu 05 and confirm with the SET key. Use key  to select whether to enable (ON) or disable (OFF) the thermostove stand-by function.

Press the ON / OFF button to exit .

How to adjust the speed of the room fan (WHEN PRESENT):

To adjust the fan speed, keep the button  pressed and adjust the desired speed with the same button. To adjust the room temperature, see **point B** instructions, **scheme 00** on the following pages.

Let's see specifically the behavior of the thermostove according to the hydraulic scheme, the presence and the stand-by mode and the chosen season

Scheme 00: boiler/thermostove connected to the heating circuit and to a sanitary kit equipped with a flow switch installed from the producer only if specified when ordered. Defeated scheme, the absence of the sanitary kit does not cause problems to the functioning of the boiler/thermostove.

The scheme is indicative and wants to demonstrate only the components that can be managed by the boiler/thermostove. Any relay pumps must be controlled separately from the boiler/thermostove.

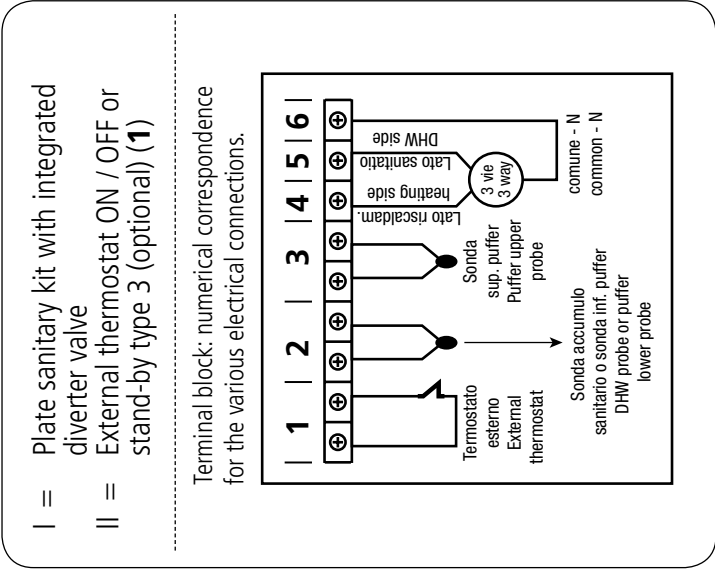
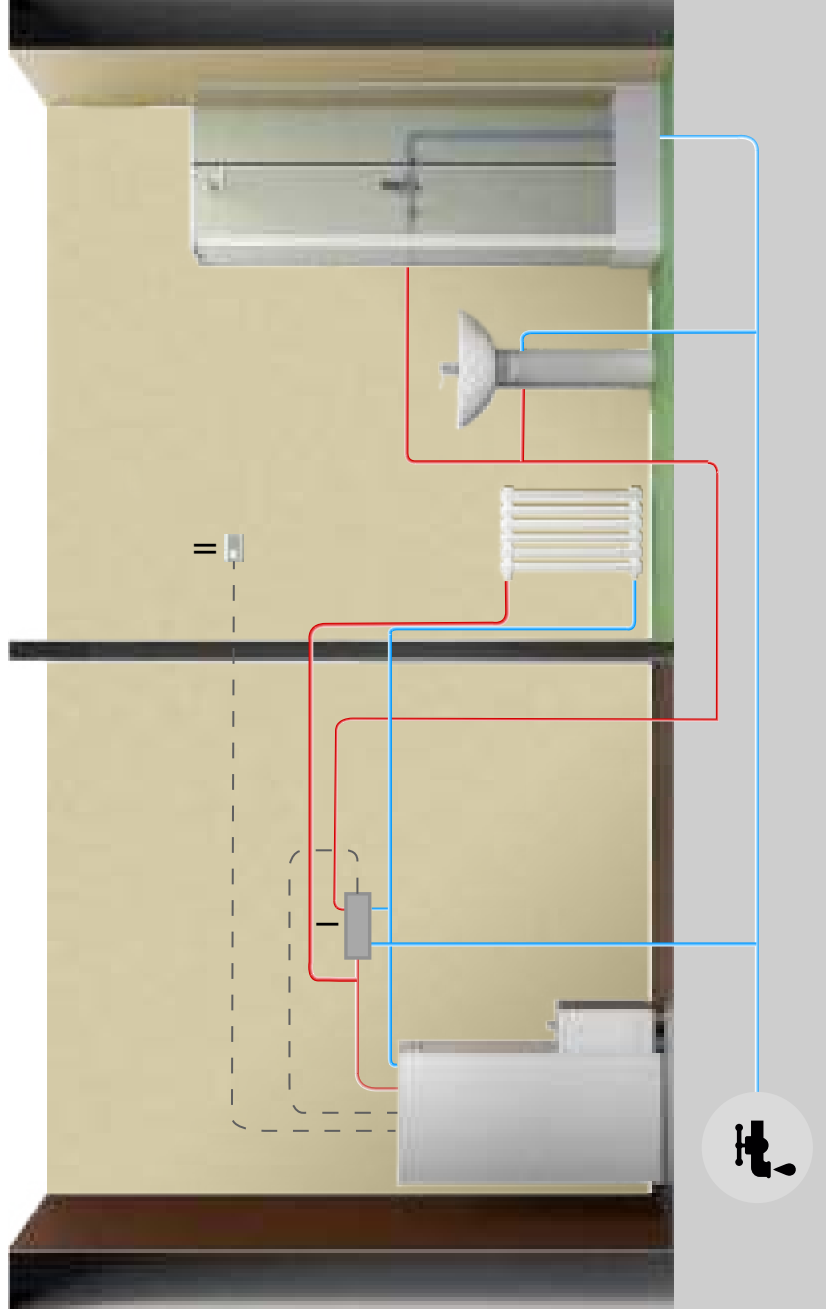

- a) To set the water temperature in the boiler/thermostove, press the . Increase or decrease degrees with the keys e .
- b) To set the desired temperature in the room (using the probe on the board) press the key. Increase or decrease degrees with the and keys.
- c) To set the work power, press the key and adjust it with the e .

Reaction from the stand-by state is when a heat increase is required to return to a chosen stand-by condition (when it is set to ON) or when there is a health risk.

Hydraulic scheme		Stand-by	Stand-by type	Season	boiler/thermostove circulator status	boiler/thermostove status
HEATING + SANITARY	SANITARY DOES NOT CALL	OFF	01 (AMB.)	WINTER	ON IF H ₂ O > PR. 25	MODULE IF PROBE H ₂ O > SET H ₂ O (a) OR IF AMB PROBE. > AIR SET (b)
HEATING + SANITARY	HEALTH CALL	OFF	01 (AMB.)	WINTER	ON IF H ₂ O > PR. 25	MODULE IF PROBE H ₂ O > 80 ° C
HEATING + SANITARY	SANITARY DOES NOT CALL	ON	01 (AMB.)	WINTER	ON IF H ₂ O > PR. 25	STAND-BY IF AMB PROBE > SET AMB. (B); MODULE SE H ₂ O > SET H ₂ O;
HEATING + SANITARY	HEALTH CALL	ON	01 (AMB.)	WINTER	ON IF H ₂ O > PR. 25	MODULE IF PROBE H ₂ O > 80 ° C
HEATING + SANITARY	SANITARY DOES NOT CALL	OFF	02 (H ₂ O)	WINTER	ON IF H ₂ O > PR. 25	MODULE IF PROBE H ₂ O > SET H ₂ O (a)
HEATING + SANITARY	HEALTH CALL	OFF	02 (H ₂ O)	WINTER	ON IF H ₂ O > PR. 25	MODULE IF PROBE H ₂ O > 80 ° C
HEATING + SANITARY	SANITARY DOES NOT CALL	ON	02 (H ₂ O)	WINTER	ON IF H ₂ O > PR. 25	STAND-BY IF PROBE H ₂ O > SET H ₂ O (a)
HEATING + SANITARY	HEALTH CALL	ON	02 (H ₂ O)	WINTER	ON IF H ₂ O > PR. 25	MODULE IF PROBE H ₂ O > 80 ° C
HEATING + SANITARY	SANITARY DOES NOT CALL	OFF	03 (TERM. ES.)	WINTER	ON IF H ₂ O > PR. 25	MODULE SE TERM. ES. SATISFIED OR IF H ₂ O PROBE > SET H ₂ O (a)
HEATING + SANITARY	HEALTH CALL	OFF	03 (TERM. ES.)	WINTER	ON IF H ₂ O > P PR. 25	MODULE SE PROBE H ₂ O > 80 ° C
HEATING + SANITARY	SANITARY DOES NOT CALL	ON	03 (TERM. ES.)	WINTER	ON IF H ₂ O > PR. 25	STAND-BY TERM. ES. SATISFIED; MODULE SE H ₂ O > SET H ₂ O; (B)
HEATING + SANITARY	HEALTH CALL	ON	03 (TERM. ES.)	WINTER	ON IF H ₂ O > PR. 25	MODULE IF PROBE H ₂ O > 80 ° C
HEATING + SANITARY	SANITARY DOES NOT CALL	OFF	ONLY 2 (H ₂ O)	SUMMER	ON IF H ₂ O > PR. 25	STAND-BY IF H ₂ O PROBE > SET FORWARD STAND-BY IN (a)
HEATING + SANITARY	HEALTH CALL	OFF	ONLY 2 (H ₂ O)	SUMMER	ON IF H ₂ O > PR. 25	MODULE SE PROBE H ₂ O > 80 ° C
HEATING + SANITARY	SANITARY DOES NOT CALL	ON	ONLY 2 (H ₂ O)	SUMMER	ON IF H ₂ O > PR. 25	STAND-BY IF PROBE H ₂ O > SET H ₂ O (a)
HEATING + SANITARY	HEALTH CALL	ON	ONLY 2 (H ₂ O)	SUMMER	ON IF H ₂ O > PR. 25	MODULE IF PROBE H ₂ O > 80 ° C

NB: By setting the "Summer" command, the boiler/thermostove will go into standby and will only switch back on if there is a sanitary water call.

Scheme 01: the boiler/thermostove is connected to a domestic hot water tank and to the heating circuit.

During the "WINTER" mode the boiler/thermostove is switched off when the contact (thermostat) below is satisfied. The boiler/thermostove is switched on when the contact (thermostat) detects a temperature below SET ACS - ΔT (ΔT can be set by technical parameters). By setting the "SUMMER" mode the temperature is considered always satisfied.

The scheme is indicative and wants to demonstrate only the components that can be managed by the boiler/thermostove. Any relay pumps must be controlled separately from the boiler/thermostove.

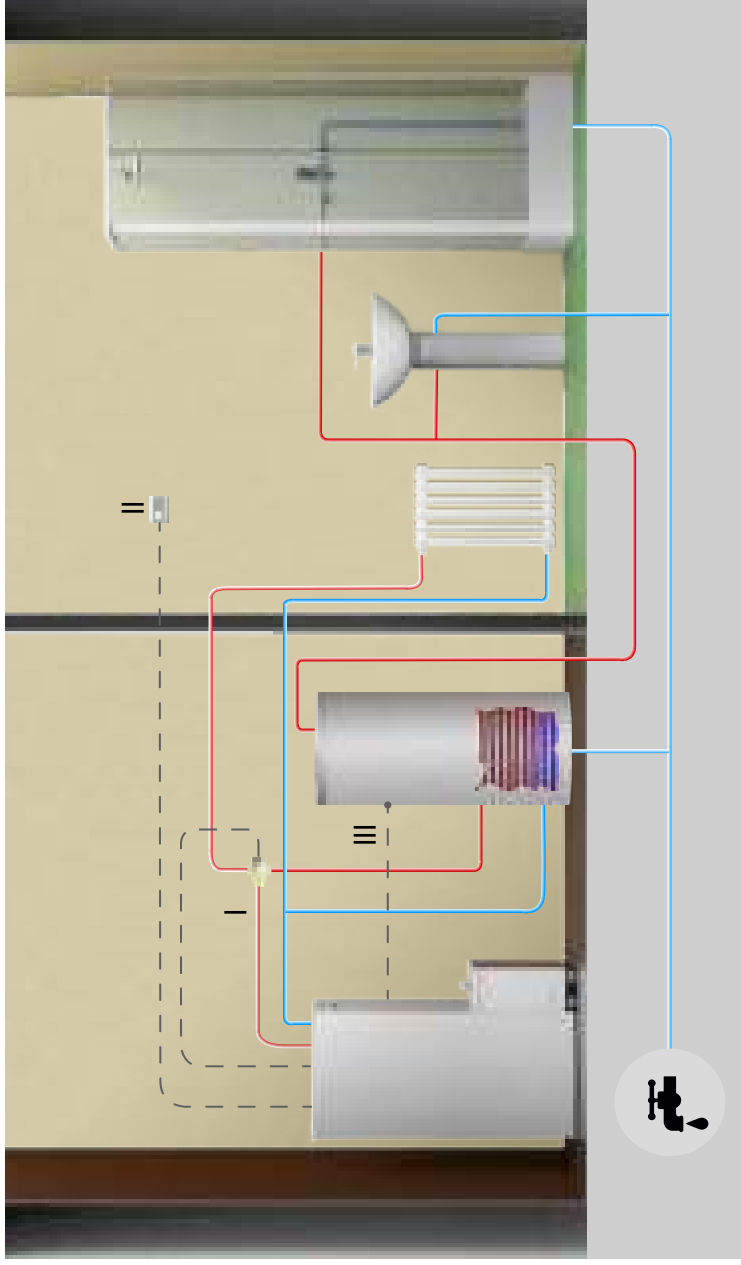

- I = Valve motorization (4 - 5 - 6)
- II = External thermostat ON / OFF or stand-by type 3 (optional) (1)
- III = ON / OFF thermostat on ACS tank (2)

Terminal block: numerical correspondence for the various electrical connections.

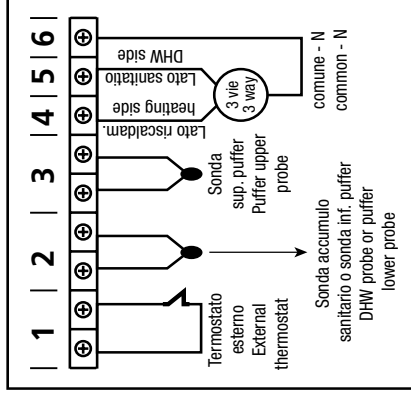

a) To set the water temperature in the boiler/thermostove, press the key. Increase or decrease degrees with keys and .

b) To set the desired temperature in the room (using the probe on the board) press the key. Increase or decrease degrees with keys and .

c) To set the work power press the key and adjust it with the and keys.

The rinsing from the stand-by state occurs automatically when a heat increase is required to return to satisfy the chosen stand-by condition (when this is set to ON) or when there is a health risk.

Hydraulic scheme		Stand-by	Stand-by state	Season	circulator heater condition	State heating boiler/thermostove
HEATING + ACS IN CONTACT	SANITARY DOES NOT CALL	OFF	01 (AMB.)	WINTER	ON IF H ₂ O > PR. 25	MODULE IF PROBE H ₂ O > SET H ₂ O (a); IF AMB PROBE > AIR SET (b)
HEATING + ACS IN CONTACT	SANITARY IN CALL	OFF	01 (AMB.)	WINTER	ON IF H ₂ O > PR. 25 e H ₂ O > ACS	MODULE IF PROBE H ₂ O > 80 ° C
HEATING + ACS IN CONTACT	SANITARY DOES NOT CALL	ON	01 (AMB.)	WINTER	ON IF H ₂ O > PR. 25	MODULE SE H2O > SET H ₂ O; (a) STAND- BY IF AMB PROBE. > SET AMB .; (B)
HEATING + ACS IN CONTACT	SANITARY IN CALL	ON	01 (AMB.)	WINTER	ON IF H ₂ O > PR. 25 e H ₂ O > ACS	MODULE IF PROBE H ₂ O > 80 ° C
HEATING + ACS IN CONTACT	SANITARY DOES NOT CALL	OFF	02 (H ₂ O)	WINTER	ON IF H ₂ O > PR. 25	MODULE IF PROBE H ₂ O > SET H2O (a)
HEATING + ACS IN CONTACT	SANITARY IN CALL	OFF	02 (H ₂ O)	WINTER	ON IF H ₂ O > PR. 25 e H ₂ O > ACS	MODULE IF PROBE H ₂ O > 80°C
HEATING + ACS IN CONTACT	SANITARY DOES NOT CALL	ON	02 (H ₂ O)	WINTER	ON IF H ₂ O > PR. 25	STAND-BY IF PROBE H ₂ O > SET H2O (a)
HEATING + ACS IN CONTACT	SANITARY IN CALL	ON	02 (H ₂ O)	WINTER	ON IF H ₂ O > PR. 25 e H ₂ O > ACS	MODULE IF PROBE H ₂ O > 80°C
HEATING + ACS IN CONTACT	SANITARY DOES NOT CALL	OFF	03 (TERM. ES.)	WINTER	ON IF H ₂ O > PR. 25	MODULE IF EXTERNAL THERMOSTAT SATISFIED OR IF PROBE H ₂ O > SET H2O (a)
HEATING + ACS IN CONTACT	SANITARY IN CALL	OFF	03 (TERM. ES.)	WINTER	ON IF H ₂ O > PR. 25 e H ₂ O > ACS	MODULE IF PROBE H ₂ O > 80°C
HEATING + ACS IN CONTACT	SANITARY DOES NOT CALL	ON	03 (TERM. ES.)	WINTER	ON IF H ₂ O > PR. 25	STAND-BY EXTERNAL THERMOSTAT SATISFIED; MODULE IF H ₂ O > SET H ₂ O; (to)
HEATING + ACS IN CONTACT	SANITARY IN CALL	ON	03 (TERM. ES.)	WINTER	ON IF H ₂ O > PR. 25 e H ₂ O > ACS	MODULE IF PROBE H ₂ O > 80°C
HEATING + ACS IN CONTACT	SANITARY DOES NOT CALL	OFF/ON	01/02/03	SUMMER	ON IF H ₂ O > PR. 25	STAND-BY
HEATING + ACS IN CONTACT	SANITARY IN CALL	OFF/ON	01/02/03	SUMMER	ON IF H ₂ O > PR. 25 e H ₂ O > ACS	MODULE IF PROBE H ₂ O > 80°C

Scheme 02 : the boiler/thermostove is connected to a technical water puffer.

The boiler/thermostove is switched off when the lower contact (thermostat) is satisfied.

The boiler/thermostove is switched on when the upper contact (thermostat) is not satisfied.

The heating water will then be taken from this puffer by means of the pumps and the relays are not controlled by the boiler/thermostove control unit.

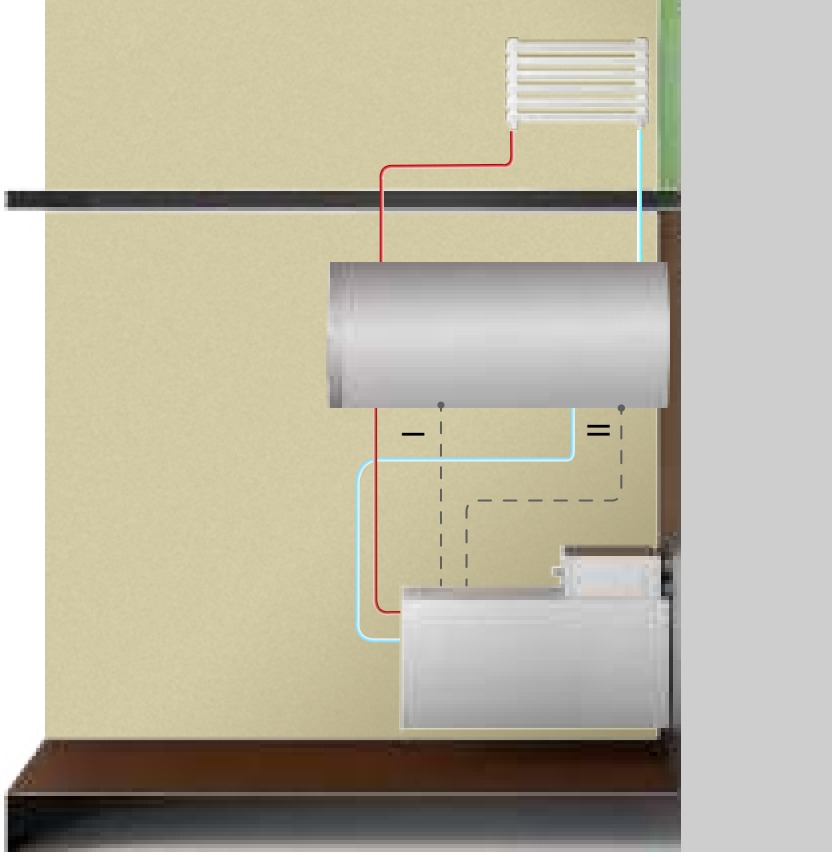

The scheme is indicative and wants to demonstrate only the components that can be managed by the boiler/thermostove. Any relay pumps must be controlled separately from the boiler/thermostove.

- I = ON / OFF higher thermostat on Technical water Puffer (3)
- II = ON / OFF lower thermostat on Technical water Puffer (2)

Terminal block: numerical correspondence for the various electrical connections.

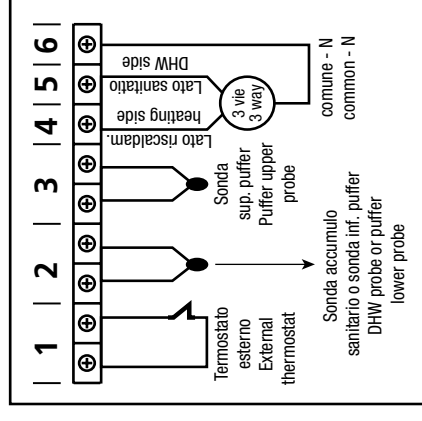

a) To set the boiler/thermostove water temperature, press the . Increase or decrease the degrees with the and .

b) To set the desired temperature in the room (using the probe on the board) press the key.

Increase or decrease degrees with the and keys.

The working power is automatically set from the machine.

The rinsing from the stand-by state occurs automatically when a heat increase is required to return to satisfy the chosen stand-by condition (when this is set to ON) or when there is a risk of hot water inside the puffer.

Hydraulic scheme		Stand-by	Stand-by state	Season	Circulator heater condition	State heating boiler/thermostove
CONTACT PUFFER	LOW AND HIGH THERMOSTAT DO NOT CALL	OFF	01/02/03	WINTER/ SUMMER	ON IF H ₂ O > PR 25	MODULE AND IF H ₂ O PROBE> 80 ° STAND-BY FORCE
CONTACT PUFFER	LOW THERMOSTAT CALLS AND HIGH DOES NOT CALL	OFF	01/02/03	WINTER/ SUMMER	ON IF H ₂ O > PR 25	WORK AND IF H ₂ O PROBE> 80 ° MODULE
CONTACT PUFFER	LOW AND HIGH CALL THERMOSTAT	OFF	01/02/03	WINTER/ SUMMER	ON IF H ₂ O > PR 25	WORK AND IF H ₂ O PROBE> 80 ° MODULE
CONTACT PUFFER	LOW THERMOSTAT DOES NOT CALL AND HIGH CALL	OFF	01/02/03	WINTER/ SUMMER	ON IF H ₂ O > PR 25	WORK AND IF H ₂ O PROBE> 80 ° MODULE
CONTACT PUFFER	LOW AND HIGH THERMOSTAT DO NOT CALL	ON	01/02/03	WINTER/ SUMMER	OFF	STAND-BY
CONTACT PUFFER	LOW THERMOSTAT CALLS AND HIGH DOES NOT CALL	ON	01/02/03	WINTER/ SUMMER	ON IF H ₂ O > PR 25	WORK AND IF H ₂ O PROBE> 80 ° MODULE
CONTACT PUFFER	LOW AND HIGH CALL THERMOSTAT	ON	01/02/03	WINTER/ SUMMER	ON IF H ₂ O > PR 25	WORK AND IF H ₂ O PROBE> 80 ° MODULE
CONTACT PUFFER	LOW THERMOSTAT DOES NOT CALL AND HIGH CALL	ON	01/02/03	WINTER/ SUMMER	ON IF H ₂ O > PR 25	WORK AND IF H ₂ O PROBE> 80 ° MODULE

Scheme 03: the boiler/thermostove is connected to a domestic hot water tank and to the heating circuit. During the “WINTER” mode the boiler/thermostove is switched off when the probe is satisfied. The boiler/thermostove is switched on when the probe detects a lower temperature to SET DHW - ΔT (ΔT settable by technical parameters). By setting the “SUMMER” mode the temperature is considered always satisfied.

The scheme is indicative and wants to demonstrate only the components that can be managed by the boiler/thermostove. Any relay pumps must be controlled separately from the boiler/thermostove.

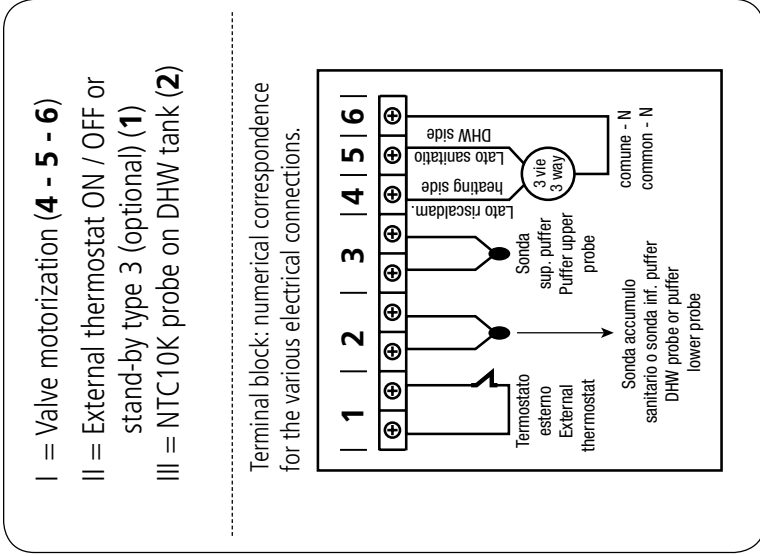
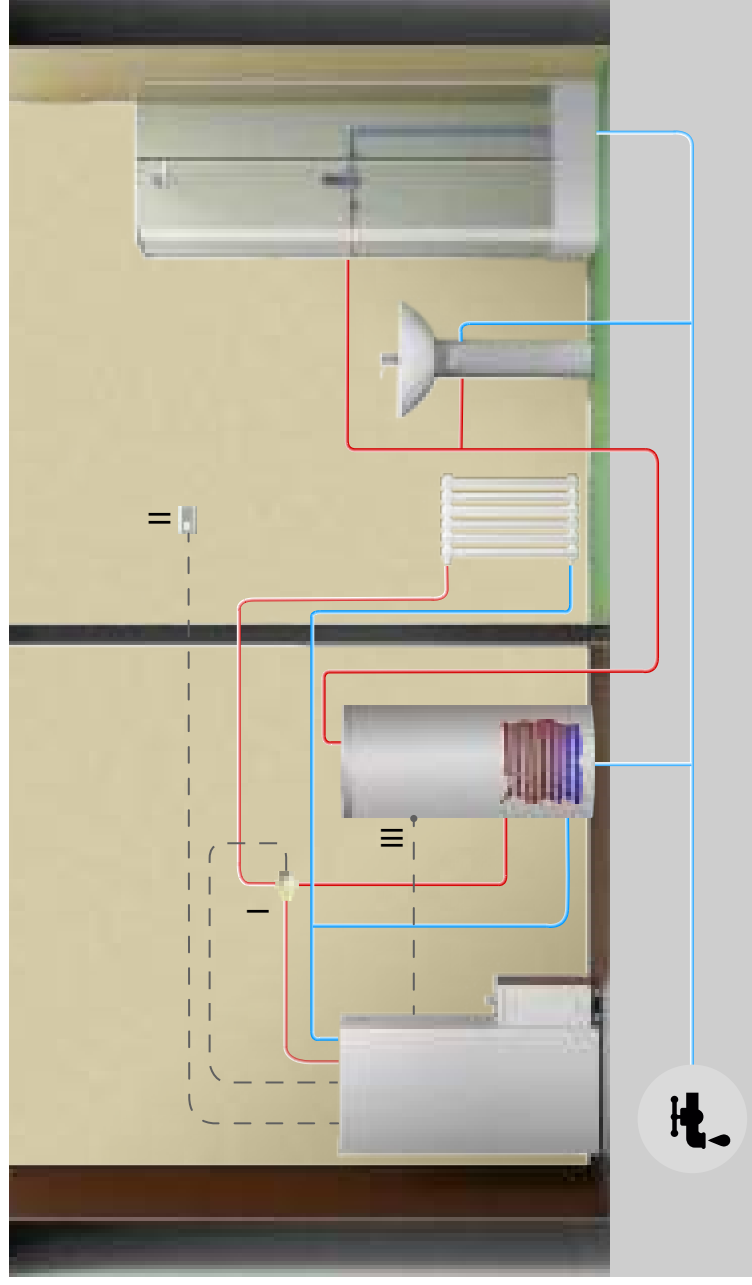

- a) To set the water temperature in the boiler/thermostove press the key. Increase or decrease the degrees with the keys and .
- b) To set the desired temperature in the room (using the probe on the board) press the key . Increase or decrease degrees with the and keys.
- c) To set the work power, press the key and adjust it with the and keys.
- d) To adjust the temperature inside the DHW tank, press the button . Increase or decrease the desired degrees with the and .

Sanitary water will always have priority on the heating.

The rinsing from the stand-by state occurs automatically when a heat increase is required to return to satisfy the chosen stand-by condition (when this is set to ON) or when there is a risk of hot water inside the DHW tank.

Hydraulic scheme	Stand-by	Stand-by state	Season	Circulator heater condition	State heating boiler/thermostove
HEATING + DHW WITH PROBE	OFF	01 (AMB.)	WINTER	ON IF $H_2O > PR 25$	RATED HEAT INPUT IF H_2O PROBE > SET H_2O (a) OR IF AMB PROBE > SET (b)
HEATING + DHW WITH PROBE	OFF	01 (AMB.)	WINTER	ON IF $H_2O > SON ACS + 3^\circ$ AND IF $H_2O > PR 25$	OPERATION AND RATED HEAT INPUT IF PROBE $H_2O > SET DHW + 10$ (d)
HEATING + DHW WITH PROBE	ON	01 (AMB.)	WINTER	ON IF $H_2O > PR 25$	STAND-BY IF AMB PROBE > AIR SET (b)
HEATING + DHW WITH PROBE	ON	01 (AMB.)	WINTER	ON IF $H_2O > ACS + 3^\circ$ AND IF $H_2O > PR 25$	OPERATION AND RATED HEAT INPUT IF PROBE $H_2O > SET ACS + 10$ (d)
HEATING + DHW WITH PROBE	OFF	02 (H_2O)	WINTER	ON IF $H_2O > PR 25$	RATED HEAT INPUT IF PROBE $H_2O > SET H_2O$ (a)
HEATING + DHW WITH PROBE	OFF	02 (H_2O)	WINTER	ON IF $H_2O > ACS + 3^\circ$ AND IF $H_2O > PR 25$	OPERATION AND RATED HEAT INPUT IF PROBE $H_2O > SET ACS + 10$ (d)
HEATING + DHW WITH PROBE	ON	02 (H_2O)	WINTER	ON IF $H_2O > PR 25$	STAND-BY IF PROBE $H_2O > SET H_2O$ (a)
HEATING + DHW WITH PROBE	ON	02 (H_2O)	WINTER	ON IF $H_2O > ACS + 3^\circ$ AND IF $H_2O > PR 25$	RATED HEAT INPUT IF PROBE $H_2O > SET ACS + 10$ (d)
HEATING + DHW WITH PROBE	OFF	03 (TERM. ES.)	WINTER	ON IF $H_2O > PR 25$	RATED HEAT INPUT IF THERMOSTAT EXTERNAL SATISFIED
HEATING + DHW WITH PROBE	OFF	03 (TERM. ES.)	WINTER	ON IF $H_2O > ACS + 3^\circ$ AND IF $H_2O > PR 25$	OPERATION AND RATED HEAT INPUT IF PROBE $H_2O > SET ACS + 10$ (d)
HEATING + DHW WITH PROBE	ON	03 (TERM. ES.)	WINTER	ON IF $H_2O > PR 25$	STAND-BY THERMOSTAT EXTERNAL SATISFIED; RATED HEAT INPUT IF $H_2O > SET H_2O$ (a);
HEATING + DHW WITH PROBE	ON	03 (TERM. ES.)	WINTER	ON IF $H_2O > ACS + 3^\circ$ AND IF $H_2O > PR 25$	OPERATION AND RATED HEAT INPUT IF PROBE $H_2O > SET ACS + 10$ (d)
HEATING + DHW WITH PROBE	OFF/ON	ONLY 2 (H_2O)	SUMMER	ON IF $H_2O > ACS + 3^\circ$ AND IF $H_2O > PR 25$	STAND-BY IF DHW PROBE > SET ACS + 1 AND FORCE ST-BY IN ON (d)
HEATING + DHW WITH PROBE	OFF/ON	ONLY 2 (H_2O)	SUMMER	ON IF $H_2O > ACS + 3^\circ$ AND IF $H_2O > PR 25$	OPERATION AND RATED HEAT INPUT IF PROBE $H_2O > SET ACS + 10$ (d)

Once the "Stand-by" condition is satisfied, before the shutdown, a time set by parameter must pass without a change of state.

Scheme 04 : the boiler/thermostove is connected to a technical water puffer. The boiler/thermostove is turned off when the lower probe is satisfied. The heating boiler/thermostove is switched on when the upper probe is not satisfied. The heating water will then be taken from this puffer by means of the pumps and the non-commanding relay from the boiler/thermostove's control unit.

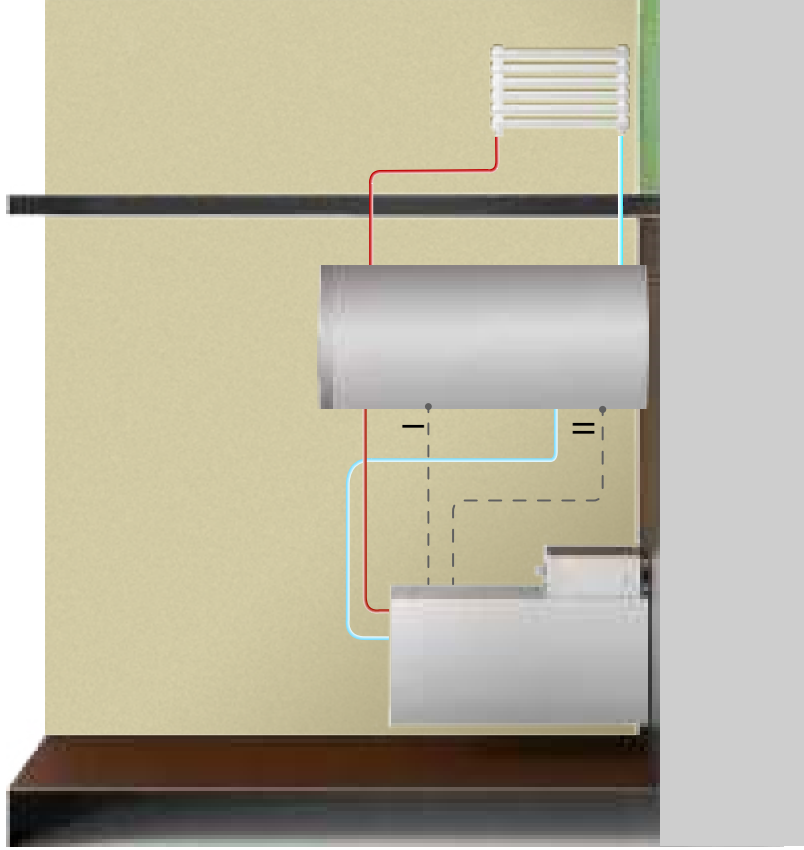

The scheme is indicative and wants to demonstrate only the components that can be managed by the boiler/thermostove. Any relay pumps must be controlled separately from the boiler/thermostove

- I = Upper probe NTC 10K on technical water puffer (3)
- II = Lower probe NTC 10K on technical water puffer (2)

Terminal block: numerical correspondence for the various electrical connections.

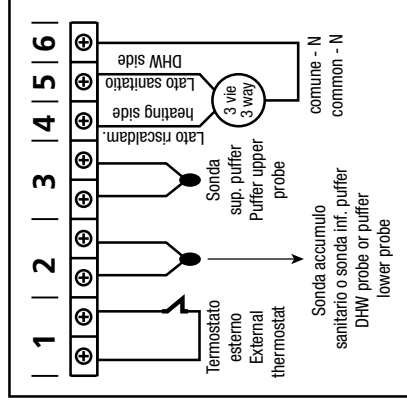

- a) To set the temperature at the top of the puffer, press the key. Use the and keys to select the desired degrees
- b) To set the temperature on the bottom of the puffer, press the key and use the and keys to select the desired degrees

The working power is set automatically by the machine.

N.B. For correct operation the upper SET must be set at a lower temperature than the lower SET.

Hydraulic scheme	Stand-by	Stand-by state	Season	3 way	Circulator heater condition	State heating boiler/thermostove
2-SIDE PUFFER (4) S1 E S2 > SET PUFFER	OFF	01/02/03	WINTER/ SUMMER	OFF	ON IF H ₂ O > PR 25 AND H ₂ O > S1 + 3°	RATED HEAT INPUT AND IF H ₂ O PROBE > 80 ° STAND-BY FORCE
2-SIDE PUFFER (4) S1 E S2 < SET PUFFER	OFF	01/02/03	WINTER/ SUMMER	ON	ON IF H ₂ O > S1 + 3° H ₂ O > PR 25	H ₂ O PROBE > 80 ° RATED HEAT INPUT
2-SIDE PUFFER (4) S1 E S2 > SET PUFFER	ON	01/02/03	WINTER/ SUMMER	OFF	OFF	STAND-BY
2-SIDE PUFFER (4) S1 E S2 < SET PUFFER	ON	01/02/03	INVERNO/ ESTATE	ON	ON IF H ₂ O > S1 + 3° H ₂ O > PR 25	H ₂ O PROBE > 80 ° RATED HEAT INPUT

Stand-by is recommended to ON

S1: Upper Probe (I)

S2: Lower Probe (II)

It is possible that the circulator works despite the boiler/thermostove is set on "OFF" or "STAND BY". This happens because the temperature of the water inside the boiler/thermostove is higher than the temperature of the puffer's top.

Scheme 05 : the boiler/thermostove is connected to a technical water puffer and to an ACS tank.

The boiler/thermostove is switched off when all the probes are satisfied. The boiler/thermostove is switched on when one of the probes is on call. The heating water will then be taken from this puffer by means of the pumps and the relays are not controlled by the boiler/thermostove control unit.

The scheme is indicative and wants to demonstrate only the components that can be managed by the boiler/thermostove. Any relay pumps must be controlled separately from the boiler/thermostove.

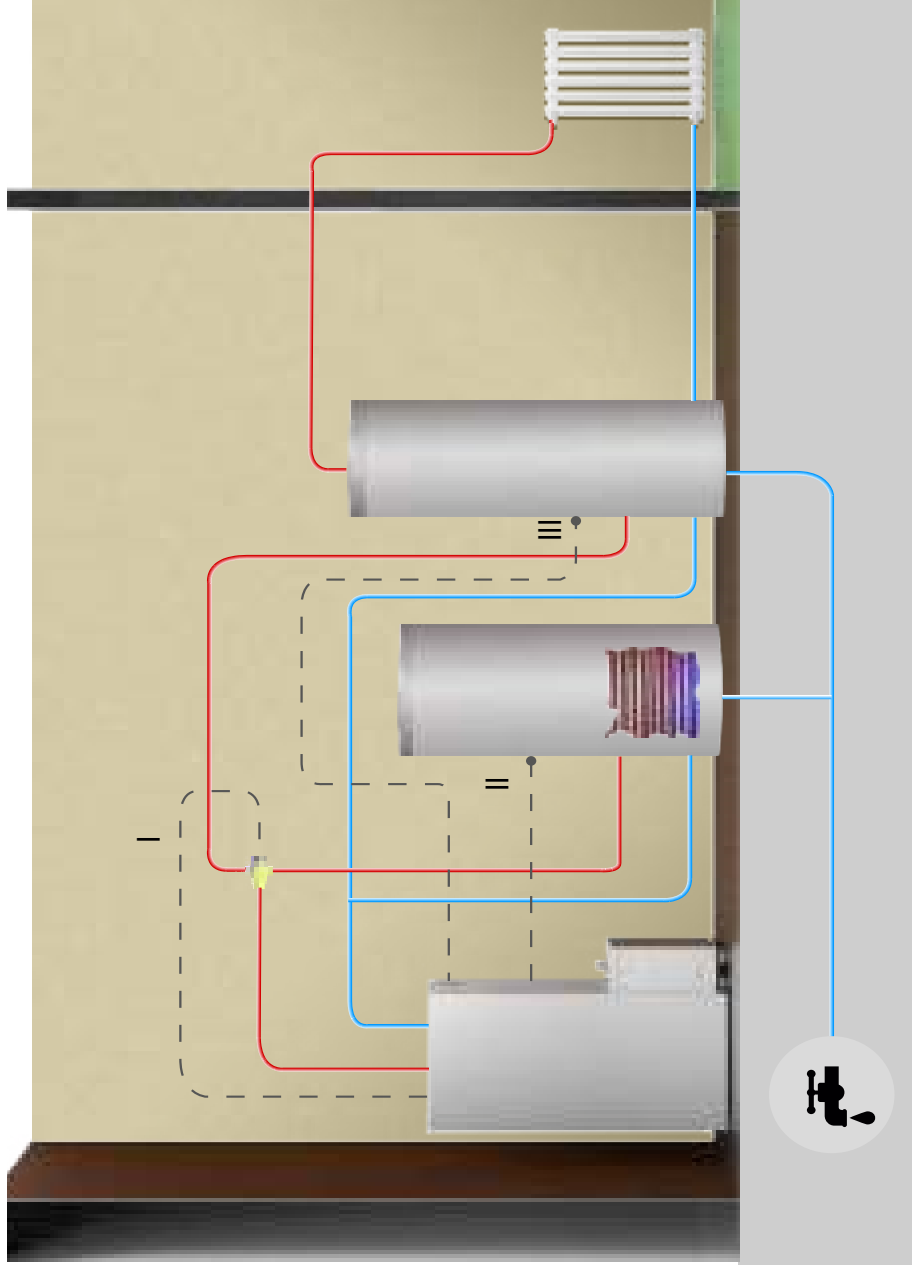

- I = Valve motorization (4-5-6)
- II = NTC 10K probe on ACS tank (2)
- III = NTC 10K probe on Technical water Puffer (3)

Terminal block: numerical correspondence for the various electrical connections.

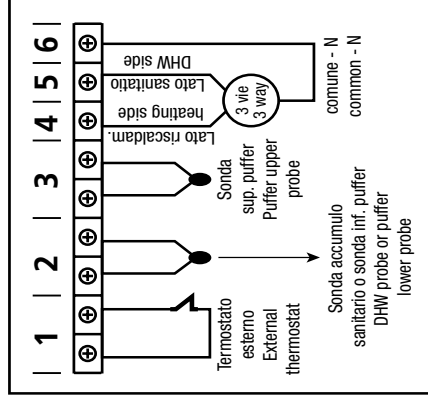

- a) To set the temperature in the DHW tank, press the key. Use the and keys to select the desired degrees
- b) To set the temperature in the technical water puffer, press the key and use the and keys to select the desired degrees
- c) To set the work power press the key and adjust it with the keys and

Sanitary water will always have priority on the heating.

Hydraulic scheme		Stand-by	Stand-by state	Season	Pump	State heating boiler/thermostove
PUFFER + DHW PROBE BOILER/ THERMOSTOVE	DHW PROBE < DHW SET AND PUFFER PROBE > SET PUFFER	OFF	01/02/03	WINTER	ON IF H ₂ O > DHW PROBE +3°	RATED HEAT INPUT AND IF H ₂ O PROBE > 80 ° STAND-BY FORCE
PUFFER + DHW PROBE BOILER/ THERMOSTOVE	DHW PROBE < DHW SET AND PUFFER PROBE > SET PUFFER	ON	01/02/03	WINTER	ON IF H ₂ O > DHW PROBE +3° IF H ₂ O > PR 25	OPERATION AND RATED HEAT INPUT H ₂ O PROBE > 80 °
PUFFER + DHW PROBE BOILER/ THERMOSTOVE	DHW PROBE > DHW SET AND PUFFER PROBE < SET PUFFER	ON	01/02/03	WINTER	ON IF H ₂ O > PUFFER +3° H ₂ O > PR 25	OPERATION AND RATED HEAT INPUT PROBE H ₂ O > 80 °
PUFFER + DHW PROBE BOILER/ THERMOSTOVE	DHW PROBE > DHW SET AND PUFFER PROBE < SET PUFFER	OFF	01/02/03	WINTER	ON IF H ₂ O > PROBE PUFFER + 3° H ₂ O > PR 25	OPERATION AND RATED HEAT INPUT H ₂ O PROBE > 80 °
PUFFER + DHW PROBE BOILER/ THERMOSTOVE	DHW PROBE > DHW SET AND PUFFER PROBE > SET PUFFER	OFF	01/02/03	WINTER	ON IF H ₂ O +5 > PROBE PUFFER	RATED HEAT INPUT
PUFFER + DHW PROBE BOILER/ THERMOSTOVE	DHW PROBE > DHW SET AND PUFFER PROBE > SET PUFFER	ON	01/02/03	WINTER	ON IF H ₂ O > PROBE DHW AND IF H ₂ O > PR PUMP ON	STAND-BY
PUFFER + DHW PROBE BOILER/ THERMOSTOVE	SONDA DHW > SET DHW	OFF/ON	SOLO 2 (H ₂ O)	SUMMER	ON IF H ₂ O > PROBE DHW +3° H ₂ O > PR 25	STAND-BY IF DHW PROBE > SET DHW + 1 AND FORCE ST-BY IN ON
PUFFER + DHW PROBE BOILER/ THERMOSTOVE	SONDA DHW < SET DHW	OFF/ON	SOLO 2 (H ₂ O)	SUMMER	ON IF H ₂ O > PROBE DHW +3° H ₂ O > PR 25	RATED HEAT INPUT IF H ₂ O PROBE > SET DHW +10

When the boiler/thermostove is working and the H₂O's boiler/thermostove = SET ACS +10° → pass in modulation

NB: Keeping the "SUMMER" command set, the technical water Puffer is always considered satisfied.



Remove any components which might burn from the firebox and from the glass (various instructions and adhesive labels)

Charge pellet

Fuel is loaded from the upper part by opening a door. Pour the pellets in the hopper. When empty, this is easier if performed in two steps:

- Pour half of the contents of the bag into the hopper and wait for the fuel to settle on the bottom.
- Then pour in the rest.



Never remove the protection grille in the hopper. When filling, do not let the sack of pellets touch any hot surfaces.











The brazier should be cleaned before each starting.

Control Panel

Button  is used to switch the machine on/off and to exit programming.

Buttons  are used to adjust temperature, for displays and for the programming functions.

Buttons  are used to adjust heating power.

LED	SYMBOL	DESCRIPTION
1		The LED lights up when a program is active.
2		The LED lights up when the resistance is active.
3		The LED lights up when the loading of pellet is active.
4		The LED lights up when the smoke fan is active.
5		The LED lights up when the room fan is active. (where present)
6		The LED lights up when the circulator is active. (Boilers and thermostoves)
7		The LED lights up when there is a warning.

1. Temperature increase
2. Temperature decrease
3. Key SET
4. Pulsante on/off
5. Operating power decrease
6. Operating power increase

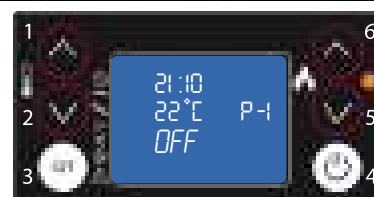

Preliminary checks

Before switching on the machine, make sure that the pellet hopper is full, the combustion chamber is clean, the glass door is closed, the power supply plug is connected and the switch on the back is set to "1."

Information on the display



TURNED OFF

The machine is off.



BRAZIER CLEANING

The machine is cleaning the basket. The smoke extractor runs at maximum speed and the pellet load is at minimum.

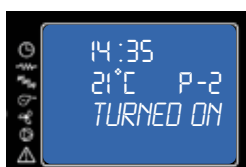

TURNED ON

The machine is in the first ignition phase. The glow plug and fume extractor are active.



OK STAND BY

All the requests have been satisfied and the machine is ready for the "STAND BY" mode.



LOAD PELLET

In this phase of the ignition process the machine starts loading the pellets into the brazier. The glow plug, the fume extractor and the cochlea engine are active.



HOLD REQUEST

The machine is in a "STAND BY" mode as everything has been satisfied and is waiting for an heating request to turn on.



FIRE PRESENT

In this phase of the ignition process the machine starts loading the pellets into the brazier. The fume extractor and the cochlea engine are active.



WAIT COOLING

The machine has to complete the cooling cycle before turning on again.

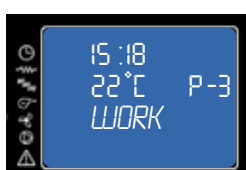

WORK

The machine is working, in this case at power 3. The detected room temperature is 21 ° C. During normal work, the fumes fan, the auger motor and the room fan are active.

Menu 02 SET CLOCK

To access the set clock option, press the "SET" button (3), with the button (5) scroll through the submenus until MENU 02 - SET CLOCK and with buttons 1 and 2 select the current day. Press the "SET" button (3) to confirm. Then use buttons 1 and 2 to set the time and press "SET" (3) to advance to the minutes setting by pressing buttons 1 and 2. By pressing set again it's possible to access various submenus in order to set the date, day, month, and year. To do so, repeat the steps indicated above, using buttons 1, 2, and 3. The following table briefly describes the structure of the menu, focusing only on those selections which are available to the user.

level 1	level 2	level 3	level 4	value
02 - set clock				
	01 - day			day of the week
	02 - hour			hour
	03 - minutes			minutes
	04 - day			day of the month
	05 - month			month
	06 - year			year

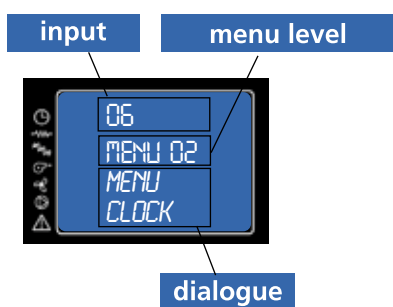

Set the current time and date. The device comes equipped with a lithium battery that allows the internal clock to operate autonomously for over 3-5 years.

Menu 03 SET CHRONO

Press the "SET" button (3) and then button 5 to arrive at the desired menu; press "SET" (3) to enter. Enter menu M-3-1 and with buttons 1 and 2 select whether or not to activate the thermostat (on/off), which allows you to program the automatic ignition of the machine. Once the thermostat is activated/deactivated, press button "4" (OFF) and continue scrolling through the submenus using button 5. Select which submenu you wish to enter in order to access the daily, weekly, and weekend programmes.

To set the ignition times and days repeat the previous steps:

- access the submenu using "SET" (3)
- adjust the days, times, and activation status (on/off) with buttons 1 and 2
- confirm by pressing the "SET" button (3)
- exit from the submenu/menu with button 4 to turn it off

The following table briefly describes the structure of the menu, focusing only on those selections which are available to the user.

level 1	level 2	level 3	level 4	value
03 - set thermostat				
	01 - activate thermos.			
		01 - activate thermos.		on/off
	02 - day programme			
		01 - daily thermostat		on/off
		02 - start 1 day		hour
		03 - stop 1 day		hour
		04 - start 2 day		hour
		05 - stop 2 day		hour

level 1	level 2	level 3	level 4	value
03 - set thermostat				
	01 - activate thermos.			
		01 - activate thermos.		on/off
	02 - day programme			
		01 - daily thermostat		on/off
		02 - start 1 day		hour
		03 - stop 1 day		hour
		04 - start 2 day		hour
		05 - stop 2 day		hour
	03 - week program.			
		01 - week thermostat		on/off
		02 - start program. 1		hour
		03 - stop program. 1		hour
		04 - monday progr. 1		on/off
		05 - tuesday progr. 1		on/off
		06 - wednesday prog. 1		on/off
		07 - thursday prog 1		on/off
		08 - friday prog 1		on/off
		09 - saturday prog 1		on/off
		10 - sunday prog 1		on/off
		11 - start program. 2		hour
		12 - stop program. 2		hour
		13 - monday progr. 2		on/off
		14 - tuesday progr. 2		on/off
		15 - wednesday prog. 2		on/off
		16 - thursday prog 2		on/off
		17 - friday prog 2		on/off
		18 - saturday prog 2		on/off
		19 - sunday prog 2		on/off
		20 - start program. 3		hour
		21 - stop program. 3		hour
		22 - monday progr. 3		on/off
		23 - tuesday progr. 3		on/off
		24 - wednesday prog. 3		on/off
		25 - thursday prog 3		on/off
		26 - friday prog 3		on/off
		27 - saturday prog 3		on/off
		28 - sunday prog 3		on/off
		29 - start program. 4		hour
		30 - stop program. 4		hour
		31 - monday progr. 4		on/off
		32 - tuesday progr. 4		on/off
		33 - wednesday prog. 4		on/off
		34 - thursday prog. 4		on/off

Menù 03 SET CHRONO

Sous menù 03 - 01 - activation chrono

Il permet d'activer et de désactiver toutes les fonctions de chrono-thermostat.

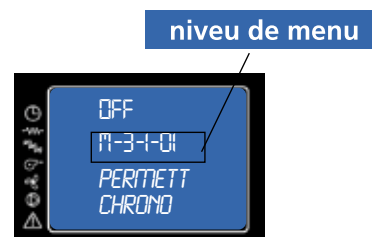

Sous menu 03 - 02 - programme quotidien

Il permet d'activer, de désactiver et de régler les fonctions de chrono-thermostat journalier.

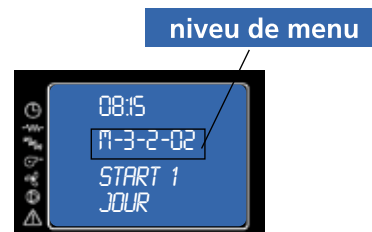

Il est possible de configurer plus tranches de fonctionnement délimitées par les horaires paramètres en fonction du tableau suivant où OFF indique à l'horloge d'ignorer la commande:

sélection	signification	valeurs possibles
START 1	heure d'activation	heure - OFF
STOP 1	heure de désactivation	heure - OFF
START 2	heure d'activation	heure - OFF
STOP 2	heure de désactivation	heure - OFF

Sous menu 03 - 03 - programme hebdomadaire

Il permet d'activer, de désactiver et de régler les fonctions de chrono-thermostat hebdomadaire.



Effectuer avec soin la programmation en évitant en général de faire superposer les heures d'activation et/ou désactivation durant la même journée dans différents programmes.

PROGRAMME 1			
niveau menu	sélection	signification	valeurs possibles
03-03-02	START PROGRAM 1	heure d'activation	heure - OFF
03-03-03	STOP PROGRAM 1	heure désactivation	heure - OFF
03-03-04	LUNDI PROGRAM 1	jour de référence	on/off
03-03-05	MARDI PROGRAM 1		on/off
03-03-06	MERCREDI PROGR 1		on/off
03-03-07	JEUDI PROGRAM 1		on/off
03-03-08	VENDREDI PROGR 1		on/off
03-03-09	SAMEDI PROGRAM 1		on/off
03-03-10	DIMANCHE PROGR 1		on/off

PROGRAMME 2			
niveau menu	sélection	signification	valeurs possibles
03-03-11	START PROGRAM 2	heure d'activation	heure - OFF
03-03-12	STOP PROGRAM 2	heure désactivation	heure - OFF
03-03-13	LUNDI PROGRAM 2	jour de référence	on/off
03-03-14	MARDI PROGRAM 2		on/off
03-03-15	MERCREDI PROGR 2		on/off
03-03-16	JEUDI PROGRAM 2		on/off
03-03-17	VENDREDI PROGR 2		on/off
03-03-18	SAMEDI PROGRAM 2		on/off
03-03-19	DIMANCHE PROGR 2		on/off

PROGRAMME 3			
niveau menu	sélection	signification	valeurs possibles
03-03-20	START PROGRAM 3	heure d'activation	heure - OFF
03-03-21	STOP PROGRAM 3	heure désactivation	heure - OFF
03-03-22	LUNDI PROGRAM 3	jour de référence	on/off
03-03-23	MARDI PROGRAM 3		on/off
03-03-24	MERCREDI PROGR 3		on/off
03-03-25	JEUDI PROGRAM 3		on/off
03-03-26	VENDREDI PROGR 3		on/off
03-03-27	SAMEDI PROGRAM 3		on/off
03-03-28	DIMANCHE PROGR 3		on/off

PROGRAMME 4			
niveau menu	sélection	signification	valeurs possibles
03-03-29	START PROGRAM 4	heure d'activation	heure - OFF
03-03-30	STOP PROGRAM 4	heure désactivation	heure - OFF
03-03-31	LUNDI PROGRAM 4	jour de référence	on/off
03-03-32	MARDI PROGRAM 4		on/off
03-03-33	MERCREDI PROGR 4		on/off
03-03-34	JEUDI PROGRAM 4		on/off
03-03-35	VENDREDI PROGR 4		on/off
03-03-36	SAMEDI PROGRAM 4		on/off
03-03-37	DIMANCHE PROGR 4		on/off

Sous menu 03 - 04 - programme week-end

Il permet d'activer, de désactiver et de régler les fonctions de chrono-thermostat le week-end (jours 5 et 6, c'est-à-dire samedi et dimanche).





REMARQUE:

dans le but d'éviter confusion et des opérations de démarrage et d'extinction non voulus, activer un programme après l'autre si on ne sait pas exactement ce qu'on souhaite obtenir.



Désactiver le programme journalier si on souhaite utiliser celui hebdomadaire. Toujours maintenir désactivé le programme week-end si on utilise celui hebdomadaire dans les programmes 1, 2, 3 et 4.

- activer la programmation week-end seulement après avoir désactivé la programmation hebdomadaire.

Menù 04 - select langue

Appuyez sur le bouton SET pour accéder au menu et appuyez sur  (5) jusqu'à MENU 04 - LANGUE SELECT. Ensuite, appuyez sur le bouton SET pour accéder au menu. Sélectionnez la langue souhaitée à l'aide des touches  (1) et  (2).

Menu 05 - stand-by mode

Press the SET key. Using the key  (2), go to menu 05 and confirm with the SET key. Using the key  (1) choose whether to enable (ON) or disable (OFF) the stand-by function.

Press the ON/OFF key  (4) to exit.

If enabled, the device will go to stand-by once the set temperature has been reached.

FOR AIR STOVES ONLY: In the presence of an external thermostat, to go to stand-by mode, both the external thermostat and the ambient probe on the stove must be satisfied.

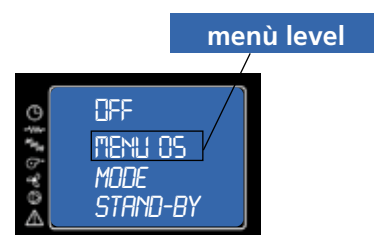

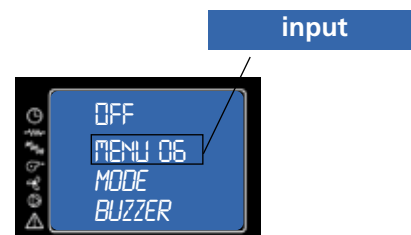

Menù 06 - buzzer mode

It allows you to enable or disable the acoustic buzzer on the controller.



Menù 07 - start load

This function is only available in OFF and allows you to load the screw feeder on first start-up, when the pellet tank is empty.

Having selected Menu 7, the writing as in Figure (A) will scroll on the display. Then press  (1). The smoke fan switches on at maximum speed, the screw feeder switches on and remains on until the time indicated on the display is up or until the key  (2) is pressed. (Figure B)

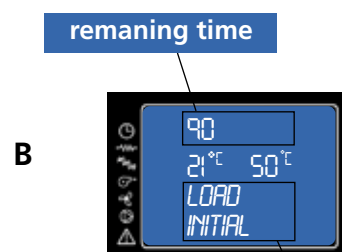
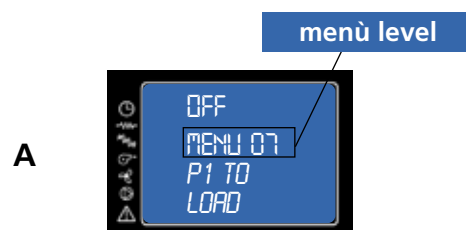

dialogue

Menù 08 - stove status

Displays the work status.

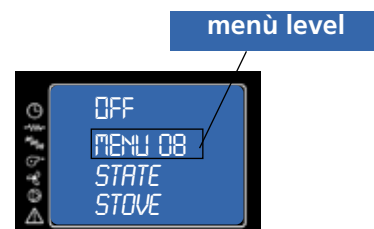

Menù 09 - technical calibration

This item of the menu is reserved for the installation technician.

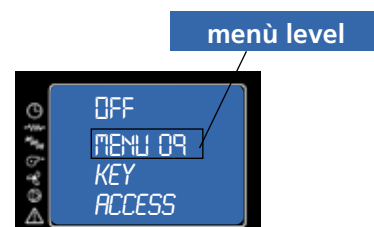

Alarm signals

In the event of a working defect, the system informs the user about the type of failure occurred. The following table summarises the alarms, kind of problem and possible solution:

Display		Kind of problem	Solution
ALAR 1	BLACK OUT	There is no power supply	As soon as the power supply is back, the Thermostove starts a cooling cycle. After completing the cycle it starts working automatically
ALAR 2	PROBE EXHAUST	The smokes sensor is broken or not connected to the pcb	Contact an Authorized Assistance Center
ALAR 3	HOT EXHAUST	Smokes temperature too high	Switch off the Thermostove, allow it to cool down and perform ordinary cleaning. If the problem persists, contact an Authorized Assistance Center for cleaning the Thermostove and the flue
ALAR 4	FAN FAILURE	Smokes extractor blocked or broken	Contact an Authorized Assistance Center
ALAR 5	NO LIGHTIN	The Thermostove cannot start up This is the first light-up	Fill in the tank with pellets Start up again
ALAR 6	NO PELLET	The pellet thermostove switched off while working	Fill in the tank with pellets
ALAR 7	SAFETY THERMAL	The water temperature exceeds 90°C. The circulating pump is blocked or there is no water in the hydraulic system	Check the power supply on the pump. Check limestone does not block the pump impeller
ALAR 8	FAILURE DEPRESS	Obstructed flue	Clean the flue or check there are no obstructed grids near the smokes exhaust
ALAR B	ERROR TRIAC COCLEA	The cochlea loads too much pellet	Contact an Authorized Assistance Center
ALAR C	PROBE WATER	Water probe faulty	Contact an Authorized Assistance Center
ALAR D	HOT WATER	Water temperature too high	Allow the thermostove to cool down. If the problem persists, contact an Authorized Assistance Center and have the hydraulic system checked
ALAR E	PRESS WATER	Water pressure too high	Allow the thermostove to cool down. If the problem persists, contact an Authorized Assistance Center and have the hydraulic system checked
SERV		The Thermostove has worked for 1300 hours. Supplementary maintenance required	Contact an Authorized Assistance Center

Regular checks should be carried out by the user, who should only contact the Authorized Assistance Center if no solution is found.

Mancata accensione

If the flame does not light up during the switching on or if the smokes temperature does not reach a suitable value in the foreseen time gap, the thermostove switches off and you will read the words **"NO LIGHTIN"**.

on the display. Press the key "On/Off" to reset the alarm. Wait until the cooling phase is completed, clean the brazier and start a new light-up.

Switching off while working

The thermostove suddenly switches off while working (for example because it has run out of pellets in the tank or because the motor reducer for pellets loading got broken). The thermostove continues working until the pellets left in the brazier ends. You will then read the words **"NO PELLETT"** on the display and the thermostove switches off. Press the key "On/Off" to reset the alarm. Wait until the cooling phase is completed. Clean the brazier and start a new light-up.

These alarms remind you that the brazier must be cleaned and installed correctly before switching on the thermostove.

There is no power supply

In the event of a power drop longer than one minute, the thermostove can exhaust some smoke in the room: this causes no risks. As soon as you have the power supply again, the thermostove will have the words **"BLACK OUT"** on the display. After completing the cooling phase, the thermostove will start up again automatically according to the previous settings. o precedente all'assenza di elettricità.



Do not attempt to start the thermostove before the required time or it may get blocked. If this occurs, switch off the switch on the back of the pellet thermostove for 1 minute, set it on again and wait 10 minutes before starting the thermostove again.



The power socket where the thermostove is connected should be fitted with "earth connection complying with regulations in force." The Manufacturer shall not be held responsible for damage to things or people resulting from negligent installation.

Manual restart thermostat

Intervention in case of danger

In case of fire, disconnect the power supply, use a fire extinguisher in accordance with, and if necessary, call the fire department and then contact an authorised qualified technical assistance



Safety devices



Pressure switch: monitors depression in the smoke duct. It is designed to shut down the pellet feed screw in the event of an obstructed flue or significant back-pressure in the presence of wind. At the time of the pressure switch will show **"ALAR-DEP-FAIL"**.



Reduction motor: if the motor stops, the thermostove continues to function until the flame goes out for lack of fuel, and until it has cooled down to the minimum level.



Flue gas temperature sensor: thermocouple that measures the temperature of the fumes while keeping the operation or shuts the thermostove when the flue gas temperature drops below the preset value.



Electrical safety: the thermostove is protected against violent surges of current (ex. lightnings) by the main fuse 4 A which is located on the control panel at the rear of the thermostove. Other fuses to protect the electronic boards are to be found on the boards themselves.



Safety thermostat with manual reset for the water temperature: if the temperature of the water tank exceeds the preset safety level of 100 °C immediately stops the operation of the thermostove and the display will show **"ALAR-SIC-FAIL"**. To restart you need to reset manually.



Water temperature probe: if the water temperature approaches the blocking temperature (100 °C), the probe requires to interrupt the supply of pellets.



Automatic vent valve: this valve eliminates the air inside the thermostove and of the heating system.



Safety valve: this valve acts to prevent over pressurization of the hydraulic system. If the pressure of the thermostove or plant exceeds 2.5 bar it drains the water from the circuit.

Anti-freeze function: if the probe in the thermostove detects a water temperature of less than 5°C, the circulation pump is automatically activated to keep the system from freezing.

Pump anti-seizure function: if the pump is not used for prolonged periods, it is activated periodically for 10 seconds, to prevent it blocks.



Tampering with the safety devices is prohibited. It is only after eliminating the cause which gave rise to the intervention of the safety system, that it is possible to relight the thermostove and thus reset the automatic operation of the sensor. To understand which anomaly has occurred, consult this manual at paragraph relating to alarms which explains what to do based on the alarm message the thermostove display.

Maintenance and cleaning



All cleaning of all parts must be carried out with the Thermostove completely cold and unplugged to avoid burns and thermal shock. The Thermostove does not need much maintenance if used with certified quality pellet. The need for maintenance varies depending on the conditions of use (switching on and off repeatedly) and depending on the performance required. It is recommended periodic monitoring of the Thermostove to check its condition.

Parts	Everyday	Every 2-3 days	Every week	Every 15 days	Every 30 days	Every 60-90 days	Every 1 year
Brazier	◇						
Cleaning the ash collection compartment with suction device		◇					
Cleaning ash tray		◇					
Door and glass cleaning		◇					
Exchanger (turbulators)	◇						
Flame beater		◇					
Cleaning the interior heat exchanger / smoke fan compartment						•	
Cleaning complete exchanger							•
Clean "T" to exhaust						•	
Flue							•
Door gasket ash						•	
Internal parts							•
Flue pipe							•
Circulation pump							•
Plate heat exchanger							•
Hydraulic components							•
Electromechanical components							•

◇ by the user / • by the authorised qualified technical assistance

BY THE USER Daily control

The Thermostove requires a simple and thorough cleaning in order to ensure a more efficient performance and smooth operation. Clean the grate using the appropriate tool from the ash and any incrustation which could obstruct the passage of air. In the case of depletion of pellets in the tank may accumulate unburned pellets in the burn pot. Always empty the residuals from the grate before each start. Remember that only a brazier located and clean properly can ensure ignition and optimal operation of your Thermostove. When positioning the crucible, carefully check that the ends of the pads completely adhere to their home and that the hole with pipe dedicated to the passage of the resistance. There should be no residual combustion in the contact zone between the edges of the crucible and the support surface on the door crucible.

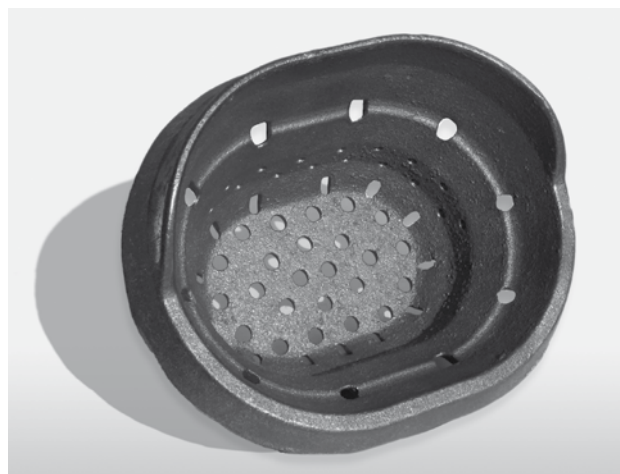



The decreased or absent cleaning can cause misfire and cause damage to the thermostove and the environment (possible emissions of soot and unburned). Do not pour the pellets may be present in the brazier to misfire.



Avoid contact with skin cleanser and eyes. In case this happens, sprinkle with plenty of water and contact the nearest medial center.

Cleaning exchanger - thermostove off

Fouling act as insulation and the thicker they are, the lower the heat that is transmitted to the water and to the structure generally. Therefore very important to perform the cleaning of the tube bundle, said exchanger also, to prevent the fouling of the same and prevent clogging and jamming of the cleaning device. Pull and push quickly for 5-6 times the lever so that the springs can remove the soot deposited on the pipes.

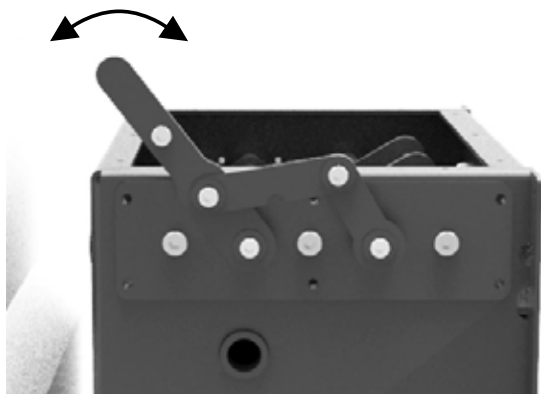

Check every 2/3 days Cleaning the ash collection compartment

Clean and empty the ash tray being careful with hot ash. The ash must be completely cold for a vacuum cleaner to be used to remove it. Only if the ash is completely cold, you can also use a canister vacuum cleaner suitable for picking up particles of a certain size.

Cleaning ash and combustion chamber including the spark plug lead.

Cleaning of stainless steel and satin-finish surfaces

Normally these surfaces do not need to be treated, but if they do, avoid cleaning them with abrasive materials. For surfaces in stainless and satin brushed steel we recommend cleaning with a paper towel or a clean dry cloth moistened with a detergent based on non-ionic surfactants (<5%) A spray glass cleaner may be used.

Cleaning of painted parts

Do not clean the painted parts with wet rags when the unit is in operation or hot to prevent thermal shock to the paint which may cause it to detach. Do not use abrasive or aggressive products or materials. Clean with damp cotton or paper towels. The silicon paints used by manufacturer possess technical characteristics that make them resistant to very high temperatures. There is however a physical limit (380° C - 400° C) beyond which the paint begins to fade or (over 450°) to vitrify; it may then flake and detach from the steel surface. If this happens, it means that temperatures have been reached that are far above those at which the unit should operate properly.



Do not use abrasive materials or harsh. Clean with damp cotton or paper towels.

Check every 7 days

Lower ash drawer cleaning

Clean bottom ash from the fallen debris during operation. You can access the ash pan by loosening the two wing nuts that hold the drawer inspection. Remove the tray, empty and clean the wall and only the corners with a suction device or with dedicated tooling. Then mount the drawer and tighten the two knobs being careful to restore the tightness, very important during operation.



Cleaning the interior baffle / smoke fan compartment.

Inside the compartment where there is the ash tray, there is a second cover, fixed by the cockerels, which gives access to the compartment at the base of the duct dedicated to the flue and the wall of the fume extractor fan. Use a suction device for thorough cleaning of the cabinet. Check the integrity of the seal in ceramic fiber.

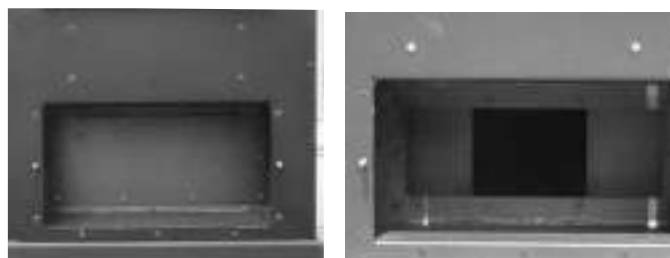

Maintenance and cleaning Thermostove with self-cleaning brazier



All cleaning of all parts must be carried out with the Thermostove completely cold and unplugged to avoid burns and thermal shock. The thermostove does not need much maintenance if used with certified quality pellet. The need for maintenance varies depending on the conditions of use (switching on and off repeatedly) and depending on the performance required. It is recommended periodic monitoring of the thermostove to check its condition.

Parts	Everyday	Every 2-3 days	Every week	Every 15 days	Every 30 days	Every 60-90 days	Every 1 year
Brazier			◇				
Cleaning the ash collection compartment with suction device		◇					
Cleaning ash tray		◇					
Exchanger (turbulators)	◇						
Flame-shell		◇					
Cleaning the interior heat exchanger / smoke fan compartment						•	
Cleaning complete exchanger							•
Clean "T" to exhaust						•	
Flue							•
Door gasket ash						•	
Internal parts							•
Flue pipe							•
Circulation pump							•
Heat exchanger (where present)							•
Hydraulic components							•
Electromechanical components							•

◇ by the user / • by the authorised qualified technical assistance

Self-cleaning brazier cleaning

Clean the brazier from the ash and any rest with the appropriate tool. They could obstruct the air passages. If the pellet in the tank is exhausted, there might be a residual unburnt pellets in the brazier. If the pellet in the tank is exhausted, there might be a residual unburnt pellets in the brazier. It's also important to clean the ash accumulated inside of the combustion room around the brazier. The frequency of this operation depends on the use of the thermostove.



Reduced or failed cleaning may cause a failed ignition with consequent damage to the thermostove and the environment (possible emissions of unburnt and soot). Do not re-introduce the pellets that may be present in the brazier for non-ignition.

Cleaning exchanger - thermostove off

Fouling act as insulation and the thicker they are, the lower the heat that is transmitted to the water and to the structure generally. Therefore very important to perform the cleaning of the tube bundle, said exchanger also, to prevent the fouling of the same and prevent clogging and jamming of the cleaning device. Pull and push quickly for 5-6 times the lever so that the springs can remove the soot deposited on the pipes.

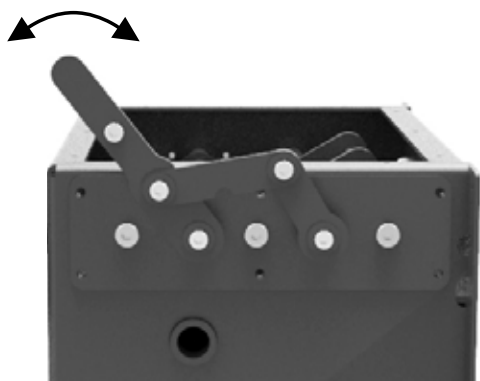

Check every 2/3 days

Cleaning the ash collection compartment

Clean and empty the ash tray being careful with hot ash. The ash must be completely cold for a vacuum cleaner to be used to remove it. Only if the ash is completely cold, you can also use a canister vacuum cleaner suitable for picking up particles of a certain size.

Cleaning ash and combustion chamber including the spark plug lead.

Cleaning of stainless steel and satin-finish surfaces

Normally these surfaces do not need to be treated, but if they do, avoid cleaning them with abrasive materials. For surfaces in stainless and satin brushed steel we recommend cleaning with a paper towel or a clean dry cloth moistened with a detergent based on non-ionic surfactants (<5%) A spray glass cleaner may be used.



Avoid contact with skin cleanser and eyes. In case this happens, sprinkle with plenty of water and contact the nearest medial center.

Cleaning of painted parts

Do not clean the painted parts with wet rags when the unit is in operation or hot to prevent thermal shock to the paint which may cause it to detach. Do not use abrasive or aggressive products or materials. Clean with damp cotton or paper towels. The silicon paints used by manufacturer possess technical characteristics that make them resistant to very high temperatures. There is however a physical limit (380° C - 400° C) beyond which the paint begins to fade or (over 450°) to vitrify; it may then flake and detach from the steel surface. If this happens, it means that temperatures have been reached that are far above those at which the unit should operate properly.



Do not use abrasive materials or harsh. Clean with damp cotton or paper towels.

Check every 7 days

Lower ash drawer cleaning

Clean bottom ash from the fallen debris during operation. You can access the ash pan by loosening the two wing nuts that hold the drawer inspection. Remove the tray, empty and clean the wall and only the corners with a suction device or with dedicated tooling. Then mount the drawer and tighten the two knobs being careful to restore the tightness, very important during operation.



Cleaning the interior baffle / smoke fan compartment.

Remove the side of the thermostove. Now the tube for the air aspiration is visible. In the lower part there is a plate; remove this plate to access to the fumes compartment. Use an ash-aspirator to remove the residues in the flue gas compartment and carefully clean the part on your left that gives access to the final part of the vertical pipe heat exchanger.



Problems and solutions



All repairs must be carried out exclusively by a specialised technician, with the Thermostove completely cold and the electric plug pulled out. Is prohibited from any unauthorized modification to the device and the replacement of parts with other non-original. The operations marked in bold type must be carried out by specialised personnel.

Check the correct combustion by the shape and colour of the flame.

PROBLEM	POSSIBLE CAUSE	REMEDY
The flame thickens at the base and the tip has not pulled upwards.	<ol style="list-style-type: none"> 1. Bad regulation that determines: <ul style="list-style-type: none"> • Too full of pellets • Low fan speed 2. The duct is obstructed or there are pressures that hamper the smooth evacuation of fumes 	<ol style="list-style-type: none"> 1. Define the adjustment of the Thermostove 2. Clean the smoke duct and check the pressure switch that measures the proper depression of the chimney
Flame swollen and bursting with color from orange to yellow with dark tips	<ol style="list-style-type: none"> 1. Combustion wrong 2. Flame oxygen deficient 	<ol style="list-style-type: none"> 1. Define the adjustment of the Thermostove 2. Make sure the air duct up to the brazier is not obstructed 3. Contact your Authorized Assistance Center

In normal combustion, the flame should have a tapered shape, compact, with character "lively" and with the tips tend to be vertical or crushed towards the back of the firebox. You have to have the feeling that the flame is pulled upwards.

Anomalies related to the scope mechanical or electronic

PROBLEM	POSSIBLE CAUSE	REMEDY
Pellet not being fed into the combustion chamber.	<ol style="list-style-type: none"> 1. Pellet hopper empty 2. Feeder screw blocked by sawdust 3. Reduction motor defective 4. Defective electronic board 5. One of the thermostats with manual reset is triggered 	<ol style="list-style-type: none"> 1. Refill pellet hopper 2. Empty the hopper and manually free the feeder screw of sawdust 3. Replace reduction motor 4. Replace electronic board 5. Reset on the back of the thermostove the safety thermostat after verifying the cause
The thermostove does not run	<ol style="list-style-type: none"> 1. Plug out of place 2. Lack of electricity supply 3. Parameter suction power to change 4. Pellet or water sensor in lockout 5. Fuse blown 6. Obstruction of nests or foreign bodies in the chimney or fireplace 	<ol style="list-style-type: none"> 1. Check the correct position of the sparkplug in the grate 2. Check that the electric socket is plugged in and that the main switch is in position "I" 3. Contact your Authorized Assistance Center 4. Wait for the cooling of the pellets or water tank and turn on the thermostove 5. Replace the fuse 6. Remove all foreign matter from the chimney or flue outlet of the barrel. It is recommended that the intervention of a chimney sweep
The fire goes out or the thermostove stops automatically	<ol style="list-style-type: none"> 1. Pellet hopper empty 2. Pellets not being fed in 3. Intervention of pellet temperature sensor 4. Door not closed properly or gaskets worn 5. Thermostove temperature is too high 6. Unsuitable pellets 7. Low pellet feed rate 8. Combustion chamber dirty 9. Smoke outlet obstructed 10. Smoke extraction motor failed 11 Pressure switch faulty or defective 	<ol style="list-style-type: none"> 1. Refill pellet hopper <p>If it is first ignition the fuel, having to go the route that goes from the tank to the brazier, may not be able to arrive on time and in the right amount programmed</p> <ol style="list-style-type: none"> 2. If after repeated ignitions did not appear in the flame, even with regular supply of pellets, the problem may be related to the components of the heater or the improper installation 3. Let the thermostove cool down completely, reset the thermostat till lockout ceases, relight thermostove; if problem persists, contact technical assistance 4. Close the door or replace the gaskets with original spare parts 5. Check for proper operation of the water pump, if necessary, replace the component 6. Change to a type of pellet recommended by the manufacturer 7. Have the fuel feed rate checked by technical service 8. Clean the combustion chamber, following instructions in the manual 9. Clean the smoke duct 10. Check the motor and replace if necessary 11. Replace the pressure
The thermostove runs for a few minutes and then goes out.	<ol style="list-style-type: none"> 1. Lighting cycle not completed 2. Temporary failure of electricity supply. 3. Smoke duct obstructed. 4. Temperature sensors defective or broken. 5. Sparkplug failure. 	<ol style="list-style-type: none"> 1. Re-run lighting cycle 2. See previous instruction 3. Clean smoke duct 4. Check and replace sensors as necessary 5. Check the plug and replace if necessary

PROBLEM	POSSIBLE CAUSE	REMEDY
Pellet build up in grate, door glass gets dirty and flame is weak	<ol style="list-style-type: none"> 1. Insufficient combustion air 2. Pellets damp or unsuitable 3. Smoke extractor motor broken 4. Bad adjustment. Wrong ratio between air and pellet 	<ol style="list-style-type: none"> 1. Check that the room air intake is present and free. Check that the pipe Ø 5 cm for air inlet is not obstructed. Clean the grate and check that all the airways are clear. Carry out a general cleaning of the combustion chamber and the smoke duct. Check the state of the door gaskets 2. Change the type of pellet 3. Check the motor and replace if necessary 4. Contact your Authorized Assistance Center
The smoke extraction motor does not work	<ol style="list-style-type: none"> 1. No electrical supply to the thermostove 2. The motor is broken 3. Defective electronic board 4. Control panel broken 	<ol style="list-style-type: none"> 1. Check the supply voltage and the protection fuse 2. Check the motor and capacitor and replace if necessary 3. Replace electronic board 4. Replace the control panel
The air fan convention never stops	<ol style="list-style-type: none"> 1. Temperature sensor temperature control defective or broken 2. Fan failure 	<ol style="list-style-type: none"> 1. Check operation of the sensor and replace if necessary 2. Check operation of the motor and replace if necessary
In the automatic position the thermostove always runs at full power	<ol style="list-style-type: none"> 1. Room thermostat set to maximum 2. Temperature sensor defective 3. Control panel defective or broken 	<ol style="list-style-type: none"> 1. Reset the thermostat temperature 2. Check the operation of the sensor and replace if necessary 3. Check the panel and replace if necessary
The thermostove starts up "alone"	<ol style="list-style-type: none"> 1. Incorrect programming of the cronothermostat 	<ol style="list-style-type: none"> 1. Check the settings of the cronothermostat
The power does not change even if you manually adjust	<ol style="list-style-type: none"> 1. The board is set to automatic correction of power in proportion to the temperature 	<ol style="list-style-type: none"> 1. Contact your Authorized Assistance Center

Anomalies related to the plumbing circuit

PROBLEM	POSSIBLE CAUSE	REMEDY
No increase in temperature with Thermostove in operation	<ol style="list-style-type: none"> 1. Incorrect combustion adjustment 2. Thermostove/system dirty 3. Insufficient Thermostove power 	<ol style="list-style-type: none"> 1. Check parameters 2. Check and clear the thermostove 3. Check that the Thermostove is properly sized for the requirements of the system
Condensation in thermostove	<ol style="list-style-type: none"> 1. Incorrect setting maximum water temperature in the thermostove 2. Insufficient fuel consumption 	<ol style="list-style-type: none"> 1. Set the Thermostove to a higher temperature. The maximum water temperature in the thermostove is 65 ° C and can not be set below 40 ° C or above 80 ° C. It is advisable to never adjust the temperature below 50/55 ° C to avoid condensation in the thermostove. Adjust the power of the pump at a higher temperature to 50/55 ° C. 2. Contact your Authorized Assistance Center

Anomalies related to the plumbing circuit

PROBLEM	POSSIBLE CAUSE	REMEDY
Radiators cold in winter but the thermostove boils	<ol style="list-style-type: none"> 1. Circulator does not run because blocked 2. Radiators have air in them 	<ol style="list-style-type: none"> 1. Free up the circulator by removing the plug and turning the shaft with a screwdriver. Check the electrical connections of the same, replace if necessary 2. Vent the radiators
Hot water in not provided	<ol style="list-style-type: none"> 1. Circulator pump blocked 	<ol style="list-style-type: none"> 1. Free the circulator pump
The thermostove boils under "modulation" that reaches the temperature set on the thermostat of the thermostove	<ol style="list-style-type: none"> 1. It 'been set to a value of thermostat too high 2. It was set too much power to the implant. 	<ol style="list-style-type: none"> 1. Lower the temperature in the thermostove 2. Reduce the value of operating power
The thermostove goes into "modulation" as it reaches the temperature set on the thermostat of the thermostove even at low temperatures of the water in the thermostove	<ol style="list-style-type: none"> 1. Modify the parameter for the maximum smoke temperature modulation to edit 2. Dirty thermostove: the fumes are too high temperature. 	<ol style="list-style-type: none"> 1. Contact your Authorized Assistance Center 2. Clean the tube bundle
High variability of domestic hot water temperature	<ol style="list-style-type: none"> 1. Water flow is too high 	<ol style="list-style-type: none"> 1. Reduce the flow of water (4/6 liters per minute)
Exits little hot water	<ol style="list-style-type: none"> 1. Insufficient water pressure in the network 2. Tap or mixer clogged with limescale 3. Water group clogged 4. The heat exchanger does not work 5. Air in: pump cavitation for the presence of air, the water does not rotate. 	<ol style="list-style-type: none"> 1. Check the setting of the pressure reducing valve 2. Install a water demineralizer 3. Check and clean the sanitary kit 4. Replace the plate heat exchanger 5. Bleed the brake system, remove air by venting the radiators.



Never turn off the heater by removing electricity. Let always complete the shutdown cycle, otherwise you may damage the structure and have trouble lighting in the future.

GENERAL GUARANTEE

All products are subject to accurate testing and are covered by warranty for 24 months from the date of purchase, documented by invoice or purchase receipt that will be presented to authorized technicians. If the document does not show up, it will be invalidate the right of the owner of the appliance. Warranty means the replacement or repair of parts of the appliance that are defective at source due to manufacturing faults.

1. Warranty covering manufacturing defects and defects in material declines:

- for unauthorized personnel work;
- for damage caused by transport or for causes not attributable to the manufacturer;
- for incorrect installation;
- for incorrect electrical connection;
- for periodic maintenance not performed;
- for outdoor accidents (lightning, floods, etc ...);
- for incorrect use and maintenance.

2. Complete replacement of the machine can only take place following the unquestionable decision by the manufacturer in special cases

3. The Company declares no responsibility for any damage that may, directly or indirectly, result in persons, things or animals as a result of non-observance of the instructions in the Instructions book and in particular concerning the installation, use and maintenance of the appliance.

GUARANTEE LIMITATIONS

Limited Warranty covers manufacturing defects, provided that the product has not been damaged by improper use, improper handling, incorrect connection, tampering, and installation errors. The following components are covered by a twelve months warranty:

- combustion burners;
- resistance.

They are not covered by warranty:

- the glass of the door;
- general gasket and fiber door;
- painting;
- tiles;
- the remote control
- Internal sides

- Any damage caused by inadequate installation and / or shortages of the consumer.

The images are purely indicative and may not match the reality of the product. Pictures are only exemplary and they are needed to understand how the product works.

This warranty excludes all the malfunctions and/or damage to equipment which is due to the following causes:

- damage caused by transport and/or movement
- all the parts resulting as faulty due to negligence or carelessness during use, wrong maintenance, installation non-compliant with manufacturer specifications (always refer to the installation and use manual of the equipment)
- wrong dimensioning compared to use or faulty installation, i.e. non-implementation of the measures necessary to guarantee execution to standard
- improper overheating of the equipment, i.e. use of fuel incompatible with the types and quantities indicated on the instructions supplied
- further damage caused by wrong user interventions in an attempt to resolve the initial fault
- aggravated damage caused by further use of the equipment by the user once the defect is noticed
- in the presence of possible corrosion, scale or breakages caused by stray current, condensate, aggression or acidity of the water, descaling treatments carried out incorrectly, no water, sludge or limescale deposits
- inefficiency of the chimneys, flues, or parts of the system on which the equipment depends
- damage caused by tampering with the equipment, atmospheric agents, natural disasters, vandalism, electrical discharges, fire, faulty electrical and/or hydraulic system
- Lack of annual maintenance of the Thermostove, by an authorised technician or qualified staff, will cause loss of warranty.

